

OterCom



CATÁLOGO

Seguro tenemos el producto
que necesitas.

2024



OterCom

es Movimiento,

*Movimiento que produce cambio,
cambio que nos lleva al desarrollo,
desarrollo que genera éxito,
éxito que se une a la perfección,*

perfección que nos lleva a nuestra esencia,

Esencia es lo que logramos en OTERCOM.

ÍNDICE

Electricidad

4

- Apagadores
- Clavijas
- Contactos
- Contactos Duplex
- Multicontactos y Conectores
- Sockets
- Cintas
- Timbres y Campanas

Cable y Extensiones

33

- Cable
- Extensión

Línea de placas Residencial

38

- Tradicional T/Q
- Muelas Marfil
- Muelas Blanco
- T/Evo Marfil
- T/Evo Blanca
- Blanca 118
- MDX Marfil
- MDX Blanca
- Innlite
- Zolar

Iluminación

54

- Foco LED
- Módulos LED
- Foco Incandescente
- Lámparas

Seguridad CFE

79

- Fusibles
- Centros de Carga
- Baterías

Obra Negra

86

- Cajas de Registro
- Canaletas
- Guías y Varilla

Abrazaderas y Grapas

91

- Grapas
- Abrazaderas
- Cinchos

Calentadores

94

- Calentadores
- Repuesto para Regadera

Parrillas

97

- Estufas
- Parrillas
- Resistencias

Plomería

101

- Regaderas
- Accesorios para Fregadero
- Mezcladoras
- Accesorios para Baño
- Mangueras
- Cespól

Herramientas

113

- Termofusora
- Candados
- Brochas
- Probadores
- Soldaduras
- Antenas
- Caimanes

Líquidos

120

- Gases
- Silicones

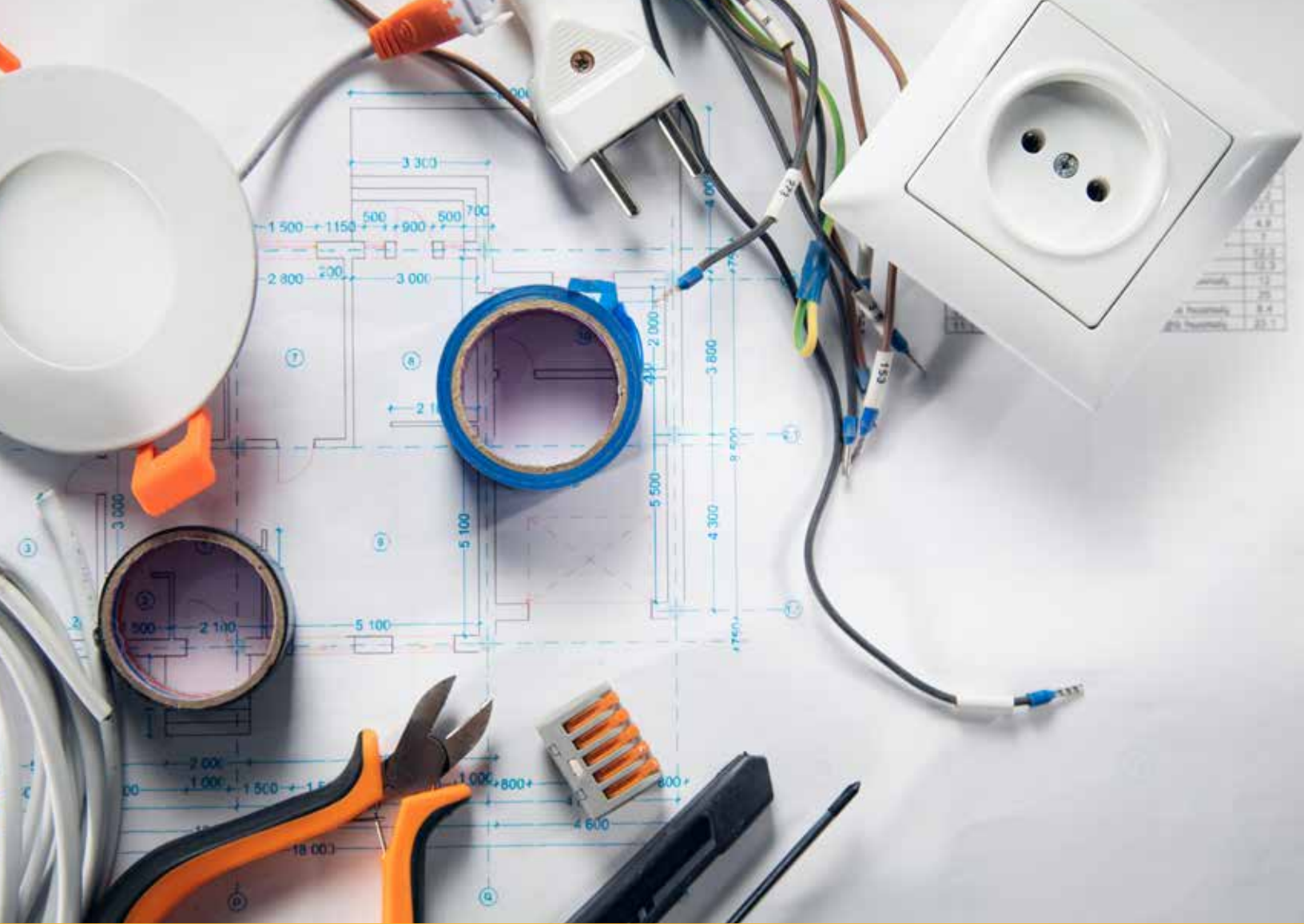

ELECTRICIDAD

APAGADORES



**APAGADOR DE PALANCA 2 TORNILLOS
CUERPO DE BAQUELITA Y PALANCA DE ACERO**

CLAVE 4-01701
127v~10A
INNER 25 / MASTER 500

**APAGADOR DE PALANCA 4 TORNILLOS
CUERPO DE BAQUELITA Y PALANCA DE ACERO**

CLAVE 4-01703
127v~10A
INNER 25 / MASTER 100



**APAGADOR DE PALANCA 3 TORNILLOS
CUERPO DE BAQUELITA Y PALANCA DE ACERO / 127V 10A**

CLAVE 4-01702
2 POSICIONES DE ENCENDIDO
INNER 25 / MASTER 500



**APAGADOR DE PALANCA COLA DE RATA
BAQUELITA Y METAL / 127V 6A**

CLAVE 4-01706
INNER 10 / MASTER 50

APAGADORES



APAGADOR DE BALANCÍN CON LUZ PILOTO

CLAVE 4-01816
250V~15A
INNER 10 / MASTER 100



APAGADOR DE PASO DESLIZABLE

CLAVE 4-01805
ES FÁCIL DE INSTALAR
COLOR BLANCO
INNER 30 / MASTER 1200



**APAGADOR DE PASO MARFIL
POLICARBONATO**

CLAVE 1-0123
127v~3A
INNER 24 / MASTER 720



APAGADOR DE PASO PERA BLANCO CHICO

CLAVE 4-01803
127V~10A
INNER 24 / MASTER 1200



APAGADOR DE PASO PERA BLANCO GRANDE

CLAVE 4-01804
127V~10A
INNER 24 / MASTER 600



**APAGADOR MINI ROTATIVO
NEGRO**

CLAVE 1-0259 NEGRO
6A 125V~
INNER 10 / MASTER 100

APAGADORES



APAGADOR PUSH PLÁSTICO

CLAVE 1-0006
INNER 10 / MASTER 1000



APAGADOR VISIBLE PLANO
COLOR MARFIL

CLAVE 4-01512
INCLUYE TORNILLERIA PARA FIJAR
125V~10A
INNER 12 / MASTER 600



APAGADOR TIMBRE VISIBLE PLANO
COLOR MARFIL

CLAVE 1-0008
INCLUYE TORNILLERIA PARA FIJAR
125V~10A
INNER 12 / MASTER 600



APAGADOR VISIBLE TIPO HUEVO
COLOR MARFIL

CLAVE 1-0016
INCLUYE TORNILLERIA PARA FIJAR
125V~10A
INNER 12 / MASTER 600

CLAVIJJAS

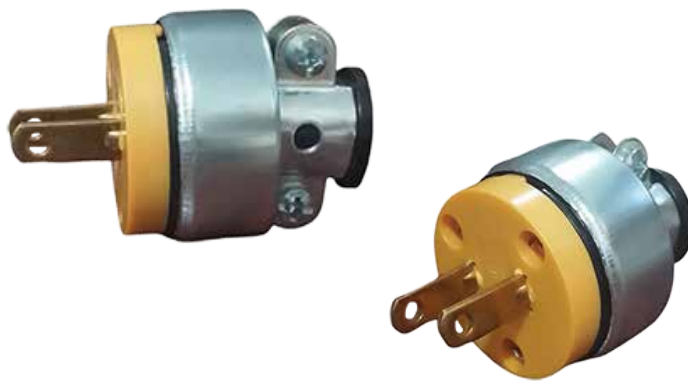

**CLAVIJA BLINDADA SENCILLA
USO INDUSTRIAL CON ABRAZADERA POLARIZADA
MATERIAL ABS Y ACERO**

**CLAVE 1-0032
INNER 25 / MASTER 300**

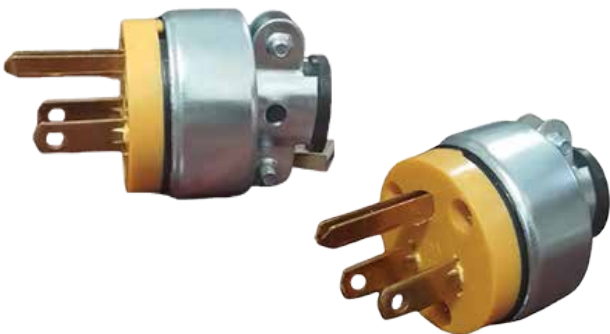

**CLAVIJA BLINDADA USO INDUSTRIAL CON TIERRA
ABRAZADERA POLARIZADA
MATERIAL ABS Y ACERO**

**CLAVE 1-0024
INNER 25 / MASTER 300**



**CLAVIJA INDUSTRIAL USO RUDO
FABRICADA EN ABS Y PVC
GALVANIZADA**

**CLAVE 1-0009
INNER 24 / MASTER 240**

CLAVIJAS



**CLAVIJA INDUSTRIAL USO RUDO CON TIERRA
MATERIAL DE ABS, POLICARBONATO Y PVC
ACABADO GALVANIZADO**

**CLAVE 1-0001
INNER 24 / MASTER 240**



**CLAVIJA INDUSTRIAL METÁLICA
USO INDUSTRIAL BLINDADA
CUERPO METÁLICO**

**CLAVE 9-004
INNER 20 / MASTER 200**



**CLAVIJA INDUSTRIAL POLARIZADA
USO SEMI-INDUSTRIAL, COMERCIAL Y DOMÉSTICO**

**CLAVE 9-007
110V/220V
INNER 20 / MASTER 200**

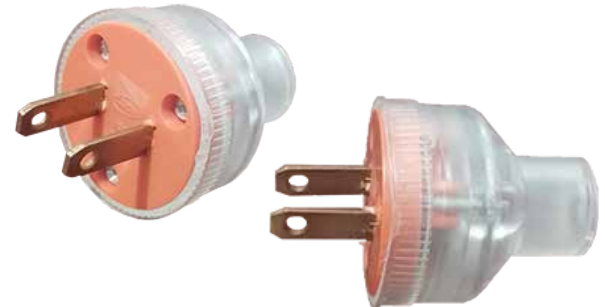

**CLAVIJA TRANSPARENTE SENCILLA
USO INDUSTRIAL HERRAJES DE LATÓN
CLAVIJA DE PLÁSTICO**

**CLAVE 1-0045
INNER 25 / MASTER 300**

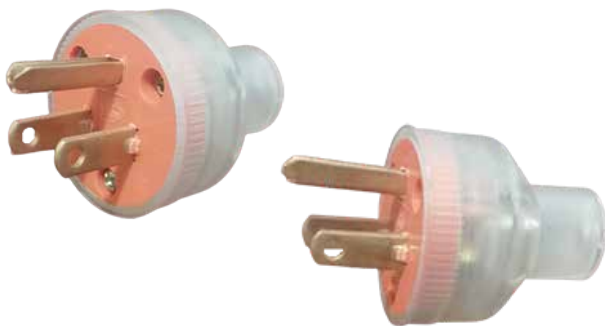

**CLAVIJA TRANSPARENTE CON TIERRA USO INDUSTRIAL
HERRAJES DE LATÓN CLAVIJA DE PLÁSTICO**

**CLAVE 1-0046
INNER 25 / MASTER 300**



**CLAVIJA REDONDA DE HULE USO DOMÉSTICO
MATERIAL PVC COLOR NEGRO**

**CLAVE 1-0031
INNER 12 / MASTER 600**



CLAVIJA OVALADA USO DOMÉSTICO
HERRAJES LATONADO
MATERIAL DE PVC NEGRO

CLAVE 1-0025
INNER 50 / 500 MASTER



CLAVIJA BISAGRA SENCILLA USO DOMÉSTICO
MATERIAL BAQUELITA
BLANCA/MARFIL

CLAVE 1-0108
INNER 30 / MASTER 1200



CLAVIJA TRILPE BISAGRA
USO DOMÉSTICO
MARFIL

CLAVE 1-0033
INNER 12 / 600 MASTER

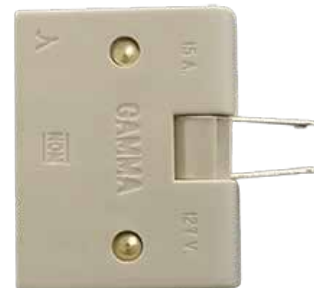

CLAVIJA TRIPLE BISAGRA
CUERPO DE BAQUELITA HERRAJE DE LATÓN
15A/127V

CLAVE 9-009
INNER 20 / MASTER 200



CLAVIJA PLANA CAFE USO DOMÉSTICO
MATERIAL BAQUELITA
COLOR CAFÉ

CLAVE 1-0057
INNER 60 / 1800 MASTER



CLAVIJA PLANA MARFIL USO DOMÉSTICO
MATERIAL BAQUELITA
COLOR MARFIL

CLAVE 1-0023
INNER 60 / 1800



**CLAVIJA CONVERTIDORA DE REDONDA A PLANO
ADAPTADOR DE LUZ ENTRADA
EUROPEA A SALIDA AMERICANA**

**CLAVE 1-0026
INNER 10 / MASTER 50**



**CLAVIJA CONVERTIDORA NARANJA
USO DOMÉSTICO MATERIAL DE PVC
110V~15A
COLOR NARANJA**

**CLAVE 1-0029
INNER 48 / MASTER 1200**



**CLAVIJA CONVERTIDORA REFORZADA NARANJA
USO DOMÉSTICO MATERIAL DE PVC DE ALTA CALIDAD
15A 125V~
COLOR NARANJA**

**CLAVE 1-0003
INNER 36 / MASTER 900**

CONTACTOS



**CONTACTO BLINDADO
USO INDUSTRIAL
MATERIAL PVC Y METAL HERRAJES DE LATÓN**

**CLAVE 1-0036
INNER 25 / MASTER 300**



**CONTACTO INDUSTRIAL USO RUDO
MATERIAL PVC HERRAJES DE LATÓN**

**CLAVE 1-0002
INNER 25 / MASTER 300**



**CONTACTO HEMBRA OVALADA
USO DOMÉSTICO
MATERIAL DE PVC POLARIZADO SIN TIERRA**

**CLAVE 4-01921
INNER 10 / MASTER 100**



**CONTACTO DUPLEX SOBREPONER
USO DOMÉSTICO
MARFIL MATERIAL BAQUELITA**

**CLAVE 1-0039
INNER 10 / MASTER 200**

CONTACTOS



CONTACTO DUPLEX DE SOBREPONER ASTRO
USO DOMÉSTICO
BLANCO
IRROMPIBLE

CLAVE 21-C08B
INNER 10 / MASTER 50



CONTACTO DUPLEX DE SOBREPONER ASTRO
USO DOMÉSTICO
MARFIL
IRROMPIBLE

CLAVE 21-C08M
INNER 10 / MASTER 50



CONTACTO DUPLEX VISIBLE
USO DOMÉSTICO
MARFIL MATERIAL ABS
HERRAJES LATÓN

CLAVE 1-0305
INNER 10 / MASTER 200



CONTACTO TRIPLE CON CLAVIJA
USO DOMÉSTICO
MARFIL MATERIAL BAQUELITA
HERRAJES DE LATÓN

CLAVE 4-01506
INNER 12 / MASTER 480



**CONTACTO TRIPLE PARA EXTESIÓN
USO DOMÉSTICO
MARFIL MATERIAL BAQUELITA
HERRAJES DE LATÓN**

**CLAVE 4-01507
INNER 12 / MASTER 480**



**CONTACTO TRIPLE CHOCOLATE
USO DOMÉSTICO
MATERIAL ABS REFORZADO / HERRAJES DE LATÓN
IRROMPIBLE**

**CLAVE 4-01515
INNER 12 / MASTER 240**



**CONTACTO TRIPLE MARFIL
USO DOMÉSTICO
MATERIAL ABS REFORZADO
HERRAJES DE LATÓN
IRROMPIBLE**

**CLAVE 4-01516
INNER 12 / MASTER 240**



**CONTACTO VISIBLE CUADRADO
USO DOMÉSTICO
MARFIL
MATERIAL ABS**

**CLAVE 4-01513
INNER 12 / MASTER 600**

CONTACTOS DUPLEX Y PLACAS



APAGADOR Y CONTACTO DUPLEX
APAGADOR 250V~
CAPACIDAD 127V, 15A

CLAVE 1-0017
INNER 10 / MASTER 200



CONTACTO DUPLEX
USO DOMÉSTICO
BLANCO MATERIAL BAQUELITA
CAPACIDAD 127V, 15A
CONTACTO DUPLEX POLARIZADO ATERRIZADO

CLAVE 1-0038
INNER 10 / MASTER 200



CONTACTO DUPLEX
USO DOMÉSTICO
MARFIL
MATERIAL BAQUELITA
CAPACIDAD 127V, 15A
CONTACTO DUPLEX POLARIZADO ATERRIZADO

CLAVE 1-0037
INNER 10 / MASTER 200



CONTACTO DUPLEX
USO INDUSTRIAL
NARANJA
MATERIAL ABS
CAPACIDAD 127V, 15A
CONTACTO DUPLEX POLARIZADO ATERRIZADO

CLAVE 1-0387
INNER 10 / MASTER 200

CONTACTOS DUPLEX Y PLACAS



PLACA DUPLEX
USO DOMÉSTICO / BLANCO / MATERIAL PLÁSTICO
PLACA PARA CONTACTO DUPLEX

CLAVE 1-0071
INNER 20 / MASTER 1000

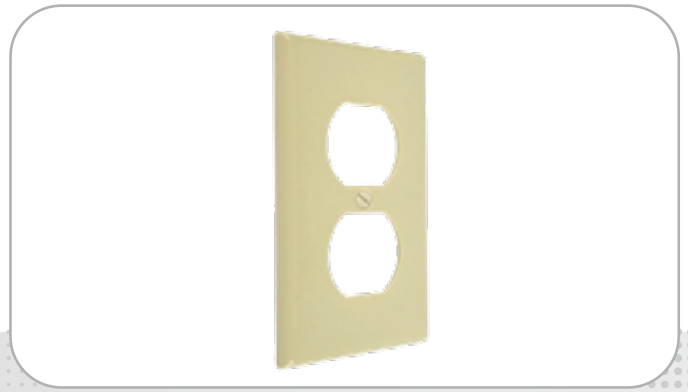

PLACA DUPLEX
USO DOMÉSTICO / MARFIL / MATERIAL PLÁSTICO
PLACA PARA CONTACTO DUPLEX

CLAVE 1-0070
INNER 20 / MASTER 1000



PLACA DUPLEX
USO INDUSTRIAL / NARANJA / MATERIAL ABS
PLACA PARA CONTACTO DUPLEX

CLAVE 1-0098
INNER 20 / MASTER 1000



PLACA DUPLEX
USO DOMÉSTICO / ALUMINIO
PLACA PARA CONTACTO DUPLEX

CLAVE 6-0035
INNER 10 / MASTER 100



PLACA DUPLEX INOXIDABLE
USO INDUSTRIAL / ACERO INOXIDABLE CALIBRE 14
ESPECIAL PARA USO RUDDO, EXTERIORES,
INDUSTRIAS, PISOS Y ÁREAS HÚMEDAS

CLAVE 21-PAI-DX
INNER 10 / MASTER 100



PLACA DUPLEX
USO INDUSTRIAL / GRIS
MATERIAL ABS
INTEMPERIE

CLAVE 4-01610
INNER 10 / MASTER 500

CONTACTO A 220V



CLAVE	DESCRIPCION
39-SE-830N	CONTACTO DUPLEX C/PLACA DE 20 AMP. NARANJA
17-SE-830B	CONTACTO DUPLEX C/PLACA DE 20 AMP. BLANCO

INTERRUPTOR DE CIRCUITO DE FALLO A TIERRA GFCI 3 VÍAS, 2 CONECTORES

APL-002

ESPECIFICACIONES	
	PLACA
	102-132~50/60 Hz
	20A
	95%
VOLTAJE DIELECTRICO	Hasta: 1250V~
ESTÁNDAR	UL943 / UL498
SCCR***	10kA
Nivel de Conmutación	Clase A*
Velocidad de Desconexión	0.025 segundos**
	115x70x40 mm
	128gr.
	PC + CU + ACERO GALVANIZADO
	OPERACIÓN: -35° A 66°C



Es un circuito interruptor de energía de acción rápida diseñado para desconectar la energía eléctrica en caso de una pérdida a tierra en 25 milisegundos.

Los interruptores de circuito por falla a tierra son vitales en una instalación eléctrica, ya que estos pueden ser la diferencia entre la protección o un lamentable accidente.

MULTICONTACTOS Y CONECTORES



MULTICONTACTO 6 TOMAS
125/127V~15A 60 HZ / CABLE CALIBRE 14AWGX3C
INTERRUPTOR ILUMINADO (ENCENDIDO Y APAGADO)
HERRAJES LATÓN / CORDÓN 75 CM

CLAVE 1-0030
INNER PZA / MASTER 50



MULTICONTACTO 6 TOMAS
CON SUPRESOR DE PICOS / 6 TOMAS
2 USB
GRIS / CORDÓN 75 CM

CLAVE 1-0568
INNER PZA / MASTER 50



BARRA MULTICONTACTOS CON SUPRESOR DE PICOS
8 CONTACTOS ATERRIZADOS
CUERPO DE ABS / PVC / CLAVIJA ATERRIZADA
CORDÓN 50 CM
APAGADOR ILUMINARIO

CLAVE 7-80339
INNER PZA / MASTER 50

MULTICONTACTOS Y CONECTORES



**BARRA MULTICONTACTOS CON SUPRESOR DE PICOS
6 CONTACTOS ATERRIZADOS / CUERPO DE ABS/PVC
CLAVIJA ATERRIZADA / CORDÓN 75 CM
APAGADOR ILUMINARIO**

CLAVE 7-80336
INNER PZA / MASTER 50



**EXTENSIÓN MINI CON CONTACTO DOBLE
BLANCO / 3 TOMAS / 15 CM**

CLAVE 1-EM-15
INNER PZA / MASTER 50



**EXTENSIÓN MINI USO RUDO
CON CONTACTO
NARANJA / 15 CM**

CLAVE 1-EMT-15
INNER PZA / MASTER 100



**EXTENSIÓN MINI USO RUDO
CON SOCKET
NARANJA / 15 CM**

CLAVE 1-EMS-15
INNER PZA / MASTER 50



EXTENSIÓN CON SOCKET BLANCA

MEDIDA	CLAVE
3 MTS	1-ES-3MT
5 MTS	1-ES-5MT
10 MTS	1-ES-10MT

INNER PZA / MASTER 100



**CABLE PARA CAFETERA
1.5 MTS
NEGRO**

CLAVE 1-0056
INNER PZA / MASTER 100

MULTICONTACTOS Y CONECTORES



**CABLE PARA GRABADORA
ALUMINIO REVESTIDO DE COBRE
1.5 MTS / NEGRO**

**CLAVE 1-0055
INNER PZA / MASTER 100**



**CONECTOR SENCILLO
15 CM / 2 VIAS
BLANCO**

**CLAVE 4-02721
INNER PZA / MASTER 50**

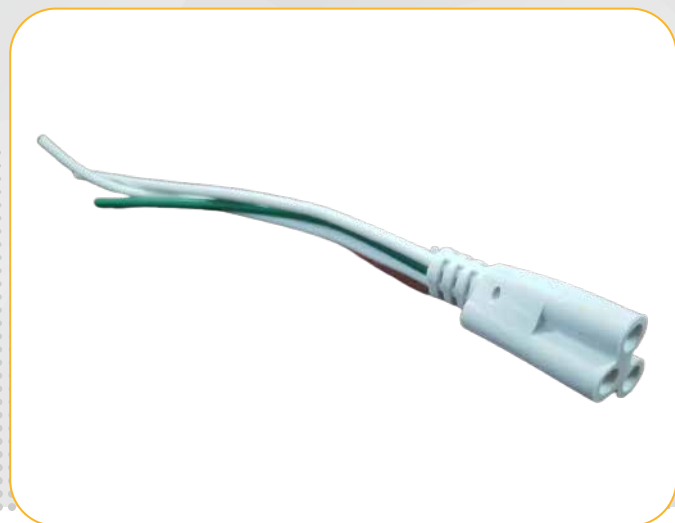

**CONECTOR SENCILLO
3 VIAS
15 CM
BLANCO**

**CLAVE 4-02720
INNER PZA / MASTER 50**



**CONECTOR EN SERIE
15 CM
BLANCO**

**CLAVE 4-02718
INNER PZA / MASTER 50**

SOCKETS



**ADAPTADOR DE BASE E-14 A E-12
NEGRO
MATERIAL PLÁSTICO**

**CLAVE 52-WAD-006
INNER PZA / MASTER 50**



**ADAPTADOR DE BASE E-26 A E-12
BLANCO
MATERIAL PLÁSTICO**

**CLAVE 52-WAD-001
INNER PZA / MASTER 12**



**SOCKET CONVERTIDOR
E-40 A E-27**

**CLAVE 1-0193
INNER 20 / MASTER 400**

SOCKETS

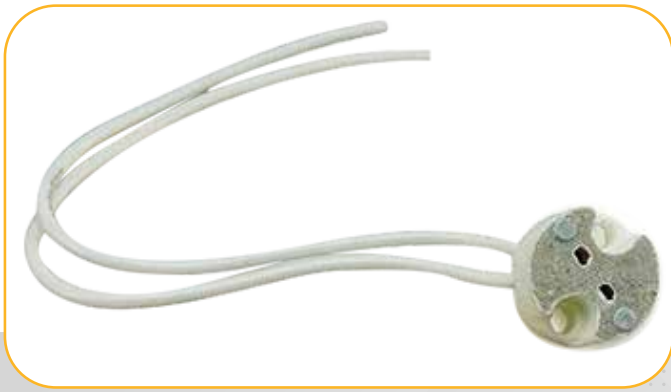

BASE PARA MR-16 REDONDA
BLANCO
250V~100W

CLAVE 4-05207
INNER 10 / MASTER 200

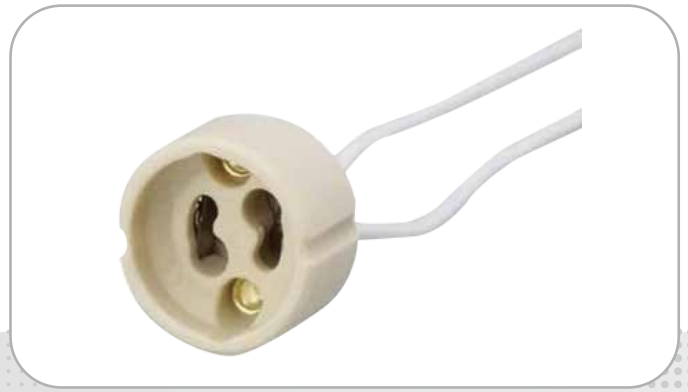

BASE PARA GU-10 REDONDA
250V~100W

CLAVE 52-WAC-006
INNER 10 / MASTER 100



BASE JUEGO CHUPÓN
FLUORESCENTE SLIM-LINE
SE VENDE POR JUEGO

CLAVE 25-BFS
INNER 10 JGS/ MASTER 100 JGS



JUEGO BASE CHUPÓN T8
BLANCO
SE VENDE POR JUEGO

CLAVE 25-BFC8
INNER 10 JGS/ MASTER 100 JGS



SOCKET BAQUELITA BLANCO
SOCKET BASE E-27
ROSCA DE LATÓN / BASE REDONDA DE 1/2
TAMAÑO 3.5"

CLAVE 1-0099
INNER 10 / MASTER 300



SOCKET BAQUELITA BLANCO
SOCKET BASE E-27
ROSCA DE LATÓN / BASE REDONDA DE 3/4
TAMAÑO 4.5"

CLAVE 1-0100
INNER 10 / MASTER 300

SOCKETS



SOCKET DE PLÁSTICO
BLANCO / MATERIAL ABS DE ALTA CALIDAD
IRROMPIBLE / BASE E-27 / TAMAÑO 3.5" 1/2 / 125V

CLAVE 1-0396
INNER 12 / MASTER 240



SOCKET DE PLÁSTICO
BLANCO / MATERIAL ABS DE ALTA CALIDAD
IRROMPIBLE / BASE E-27 / TAMAÑO 4.5" 3/4 / 125V

CLAVE 1-0397
INNER 12 / MASTER 240



SOCKET PORCELANA
BLANCO / SOCKET BASE E-27 / ROSCA DE ALUMINIO
BASE REDONDA DE 1/2 / TAMAÑO 3.5"

CLAVE 1-0095
INNER 10 / MASTER 120



SOCKET PORCELANA
BLANCO / SOCKET BASE E-27 / ROSCA DE ALUMINIO
BASE REDONDA DE 3/4 / TAMAÑO 4.5"

CLAVE 1-0096
INNER 10 / MASTER 60



SOCKET REDONDO BLOCK 1/2 BLANCO 4"
BLANCO
BAQUELITA
1/2 4"

CLAVE 11-SR12B0
INNER PZA / MASTER 120



SOCKET REDONDO BLOCK 3/4 BLANCO 5"
BLANCO
BAQUELITA
3/4 5"

CLAVE 11-SR34B0
INNER PZA / MASTER 120

SOCKETS



**SOCKET PORCELANA
BLANCO / BASE CUADRADA / VOLTAJE 127V~
TAMAÑO DE LA BASE E-27**

**CLAVE 1-0083
INNER 20 / MASTER 240**



**SOCKET BASE CUADRADA
PLÁSTICO
IRROMPIBLE**

**CLAVE 1-0087
INNER 20 / MASTER 240**



**SOCKET TIPO ITALIANO
MARFIL / CUERPO ABS
127V~250V~150W**

**CLAVE-50-92-1468 50-92-1468-B
INNER 10 / MASTER 200 COLOR BLANCO**



**SOCKET PORCELANA / BLANCO
ENTRADA 5 1/2" / CASQUILLO ATORNILLADO LATONADO
BASE REDONDA**

**CLAVE 1-0089
INNER 100 / MASTER 1000**



**SOCKET PORCELANA
BLANCO / ENTRADA 7 1/2"
CASQUILLO ATORNILLADO LATONADO
BASE E-12, 127V~660W**

**CLAVE 1-0090
INNER 100 / MASTER 1000**



**SOCKET CON CLAVIJA
CAFÉ
MATERIAL BAQUELITA-LATÓN
BASE E-27**

**CLAVE 1-0081
INNER 12 / MASTER 600**



**SOCKET CON CLAVIJA
MARFIL / MATERIAL BAQUELITA-LATÓN
BASE E-27**

**CLAVE 4-02304
INNER 12 / MASTER 600**



**SOCKET DOBLE
CAFÉ / MATERIAL BAQUELITA
VOLTAJE 127V~ / ENTRADA DE FOCO E-27**

**CLAVE 1-0076
INNER 10 / MASTER 300**



**SOCKET LADRÓN CON CADENA
CAFÉ / MATERIAL BAQUELITA
ENTRADA E-27**

**CLAVE 1-0085 / 5-117531
INNER 10 / MASTER 300**



**SOCKET LADRÓN SENCILLO
CAFÉ / MATERIAL BAQUELITA
ENTRADA E-27**

**CLAVE 1-0086
INNER 12 / MASTER 600**



**SOCKET LADRÓN CON CLAVIJA
MATERIAL BAQUELITA Y HERRAJES DE LATÓN
VOLTAJE 127V~ / BASE E-27**

**CLAVE 1-0079
INNER 12 / MASTER 600**



**SOCKET PORCELANA CON CABLES
BLANCO / CASQUILLO LATONADO
BASE E-26 / 127V~**

**CLAVE 1-0093
INNER 20 / MASTER 400**

SOCKETS



**SOCKET PORCELANA CON ESCUADRA
BLANCO / CASQUILLO LATONADO
BASE E-26
127V~**

**CLAVE 1-0092
INNER 20 / MASTER 400**



**SOCKET PORCELANA CON NIPLA
BLANCO / CASQUILLO LATONADO
BASE E-26
127V~**

**CLAVE 1-0094
INNER 20 / MASTER 400**



**SOCKET DE INTEMPERIE VINIL / PORCELANA
MATERIAL PVC Y PORCELANA
USO EXTERIOR O INTERIOR
VOLTAJE 127V~
BASE E-27**

**CLAVE 1-0084
INNER 40 / MASTER 400**



**SOCKET DE INTEMPERIE REFORZADO
MATERIAL PVC
USO EXTERIOR O INTERIOR
VOLTAJE 127V~**

**CLAVE 1-0138
INNER 36 / MASTER 432**



SOCKET SENCILLO ASTRO
MATERIAL POLICARBONATO
IRROMPIBLE
BASE E-26 / COLOR NEGRO

CLAVE 21-SSN
INNER PZA / MASTER 100



SOCKET SENCILLO ASTRO
MATERIAL POLICARBONATO
IRROMPIBLE
BASE E-26 / COLOR BLANCO

CLAVE 21-SSB
INNER PZA / MASTER 100



SOCKET REFORZADO
CAFÉ
IRROMPIBLE / BASE E-27
CUENTA CON ROSCA EN LA TAPA

CLAVE 1-0080
INNER 20 / MASTER 600



SOCKET REFORZADO
MARFIL
MATERIAL BAQUELITA / BASE E-27
CUENTA CON ROSCA EN LA TAPA

CLAVE 1-0122
INNER 20 / MASTER 600

CINTAS



**CINTA DE AISLAR LEÓN
CHICA 7 MTS**

**CLAVE 1-0176
COLOR NEGRO
INNER 10 / MASTER 500**



**CINTA DE AISLAR LEÓN
GRANDE 17 MTS**

**CLAVE 1-0005
COLOR NEGRO
INNER 10 / MASTER 250**



**CINTA DE AISLAR IGESA
CINTA DE AISLAR DE PVC
16.76 MTS**

**CLAVE 31-02060
INNER 10 / MASTER 200**



**CINTA DE AISLAR NITTO
CINTA DE AISLAR PLÁSTICA
18 MTS**

**CLAVE 54-NITTO21
INNER 10 / MASTER 200**



**CINTA DE AISLAR
NEGRA / 19MM X 18M / ESPESOR 0.15 MM
ADHESIVO ACRÍLICO / RETARDANTE AL FUEGO**

CLAVE 37-5708
INNER 10 / MASTER 200



**CINTA DE AISLAR
BLANCA / 19MM X 18M / ESPESOR 0.15 MM
ADHESIVO ACRÍLICO / RETARDANTE AL FUEGO**

CLAVE 37-5763
INNER PZA / MASTER 120



**CINTA DE AISLAR
AZUL / 19MM X 18M / ESPESOR 0.15 MM
ADHESIVO ACRÍLICO / RETARDANTE AL FUEGO**

CLAVE 37-5761
INNER PZA / MASTER 120



**CINTA DE AISLAR
ROJO / 19MM X 18M / ESPESOR 0.15 MM
ADHESIVO ACRÍLICO / RETARDANTE AL FUEGO**

CLAVE 37-5760
INNER PZA / MASTER 120



**CINTA DE AISLAR
VERDE / 19MM X 18M / ESPESOR 0.15 MM
ADHESIVO ACRÍLICO / RETARDANTE AL FUEGO**

CLAVE 37-5762
INNER PZA / MASTER 120



**CINTA DE MONTAJE PARA USO GENERAL
19MM X 5M / SOSTIENE HASTA 900 g / ALTA FIJACIÓN
Y PERMANENCIA / CINTA DE ESPUMA CON DOBLE ADHESIVO
RESISTENTE A LA HUMEDAD Y RAYOS UV**

CLAVE 7-66341
INNER 12 / MASTER 48



CINTA DE AISLAR
NEGRA / 19MM X 9M / ESPESOR 0.18 MM
ADHESIVO ACRÍLICO / RETARDANTE AL FUEGO

CLAVE 5-105102
INNER 12 / MASTER 144



CINTA DE MONTAJE PARA USO GENERAL
19MM X 5M / SOSTIENE HASTA 900 g / ALTA FIJACIÓN
Y PERMANENCIA / CINTA DE ESPUMA CON DOBLE ADHESIVO

CLAVE 5-109015 AKSI
INNER PZA / MASTER 144



CINTA PARA DUCTO 0.24MM 10MTS
CLAVE 5-109051
INNER 10P / MASTER 40P



CINTA PARA DUCTO 0.16MM 10MTS
CLAVE 5-305911
INNER 10P MASTER 40P

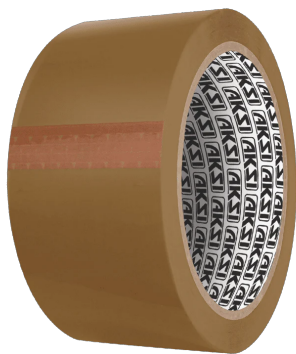

CINTA DE EMPAQUE CANELA 48MM X
40MTS
CLAVE 5-109001
INNER 6P / MASTER 12P



CINTA TRANSPARENTE 48MM
CLAVE 5-109004 40MTS
CLAVE 5-109005 50MTS
INNER 6P / MASTER 12P

TIMBRES Y CAMPANAS



TIMBRE INALÁMBRICO CON CLAVIJA
TRANSMISOR 1 BATERIA 12Vcc "23A" / RECEPTOR 127V~ 60Hz 2.5W
32 SONIDOS SELECCIONABLES / 100 MTS DE ALCANCE
MATERIAL PLÁSTICO

CLAVE 1-TL-8811
INNER PZA / MASTER 60



TIMBRE INALÁMBRICO
TRANSMISOR 1 BATERIA "23A" 12V
RECEPTOR 3 BATERIAS AA 1.5 v (NO INCLUIDAS)
36 MELODIAS / 80 MTS DE ALCANCE
3 NIVELES E VOLUMEN
INDICADOR LED

CLAVE 7-81942
INNER PZA / MASTER 60



TIMBRE INALÁMBRICO
TRANSMISOR 1 BATERIA "23A" 12V
RECEPTOR 3 BATERIAS AA 1.5 v (NO INCLUIDAS)
36 MELODIAS / 80 MTS DE ALCANCE
INDICADOR LED

CLAVE 7-81946
INNER PZA / MASTER 60

TIMBRES Y CAMPANAS



**TIMBRE DIN DON
MARFIL
125V~ / MATERIAL PLÁSTICO
EXCELENTE SONIDO**

**CLAVE 1-0463
INNER PZA / MASTER 80**



**TIMBRE PAJARITOS
MARFIL / CAPACIDAD 127V, 60 Hz, 350 mA
MATERIAL PLÁSTICO ABS
SONIDO DE PAJARITOS**

**CLAVE 4-03005
INNER PZA / MASTER 60**



CAMPANA INDUSTRIAL

ESPECIFICACIONES

2.5" 110V~360mA

4" 110V~17W

6" 127V~28W

INNER PZA

CLAVE

50-92-8318

50-92-8338

50-92-9417



**TIMBRE ZUMBADOR
MATERIAL PLÁSTICO
USO EXTERIOR
COLORES**

**CLAVE 6-0031
INNER PZA / MASTER 50**



CABLE DE COBRE Y EXTENSIONES

CABLES



CABLE THW #08
99.98 COBRE ELECTROLÍTICO
ANTI FLAMA / PVC VIRGEN
90 MTS
BLANCO, NEGRO, ROJO, VERDE

CLAVE 11-RC08XC

CABLE THW #10
99.98 COBRE ELECTROLÍTICO
ANTI FLAMA / PVC VIRGEN
90 MTS
BLANCO, NEGRO, ROJO, VERDE

CLAVE 11-RC10XC

CABLE THW #12
99.98 COBRE ELECTROLÍTICO
ANTI FLAMA / PVC VIRGEN
90 MTS
BLANCO, NEGRO, ROJO, VERDE

CLAVE 11-RC12XC

CABLE THW #14
99.98 COBRE ELECTROLÍTICO
ANTI FLAMA / PVC VIRGEN
90 MTS
BLANCO, NEGRO, ROJO, VERDE

CLAVE 11-RC14XC

CABLES



CABLE THW #06
 99.98 COBRE ELECTROLÍTICO
 ANTI FLAMA / PVC VIRGEN
 100MTS, SOLO EN COLOR NEGRO Y SOBREPEDIDO
 NEGRO

CLAVE 11-RC06XC



CABLE POT
 99.98 COBRE ELECTROLÍTICO
 ANTI FLAMA / PVC VIRGEN
 90 MTS / COLOR BLANCO

CALIBRE	CLAVE
#12	11-RP12XD
#14	11-RP14XD
#16	11-RP16XD
#18	11-RP18XD



CABLE DESNUDO
 99.98 COBRE ELECTROLÍTICO
 100 MTS

CALIBRE	CLAVE
#10	11-RD10
#12	11-RD12
#14	11-RD14

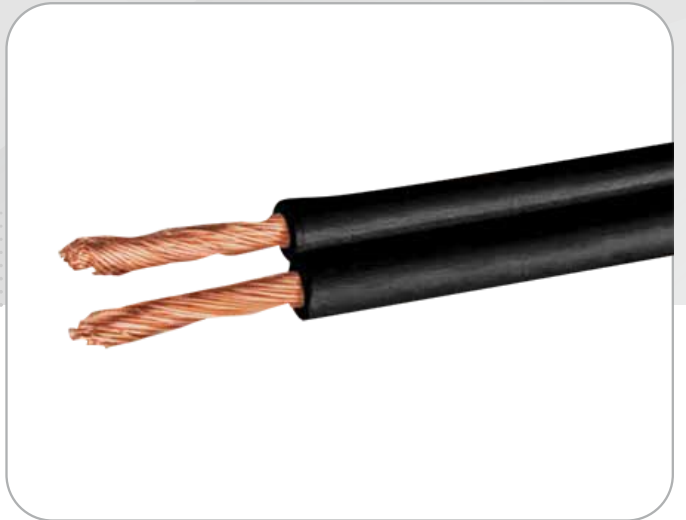

CABLE POT
 99.98 COBRE ELECTROLÍTICO
 ANTI FLAMA / PVC VIRGEN
 100 MTS / COLOR NEGRO
PRODUCTO POR TEMPORADA

CALIBRE	CLAVE
#16	11-RP16XD-N

CABLE USO RUDO EN NUEVA PRESENTACIÓN DE 50MTS.



CABLE USO RUDO

99.98 COBRE ELECTROLÍTICO / ANTI FLAMA / FLEXIBLE
600 VLTS / PVC VIRGEN / 50 MTS/ COLOR NEGRO

CALIBRE	CLAVE	CALIBRE	CLAVE
#2X10	11-210-133	#3X10	11-310-139
#2X12	11-212-134	#3X12	11-312-137
#2X14	11-214-135	#3X14	11-314-136
#2X16	11-216-140	#3X16	11-316-138
#2X18	11-218-141		

CABLE USO RUDO

99.98 COBRE ELECTROLÍTICO / ANTI FLAMA / FLEXIBLE
600 VLTS / PVC VIRGEN / 100 MTS/ COLOR NEGRO

CALIBRE	CLAVE	CALIBRE	CLAVE
#2X10	11-RR210X	#3X10	11-RR310X
#2X12	11-RR212X	#3X12	11-RR312X
#2X14	11-RR214X	#3X14	11-RR314X
#2X16	11-RR216X	#3X16	11-RR316X
#2X18	11-RR218X	#3X18	11-RR318X



CABLE PARA BOCINA BICOLOR
MATERIAL CCA (ALEACIÓN)
LEÓN 100 MTS

CALIBRE	CLAVE
#18	36-350
#22	6-0039



CABLE PARA BOCINA POLARIZADO
MATERIAL CCA (ALEACIÓN)
LEÓN 100 MTS

CALIBRE	CLAVE
#14	36-017
#16	36-018
#18	36-019
#22	36-021

EXTENSIONES

EXTENSIÓN CALIBRE #16

BLANCA

MEDIDA	CLAVE	INDIVIDUAL
2 mts.	1-0427	Pieza
3 mts.	1-0428	Pieza
4 mts.	1-0429	Pieza
5 mts.	1-0430	Pieza
6 mts.	1-0431	Pieza
8 mts.	1-0432	Pieza
10 mts.	1-0426	Pieza



EXTENSIÓN USO RUDO CALIBRE #18

NARANJA

MEDIDA	CLAVE	INDIVIDUAL
1 mts.	1-0311	Pieza
2 mts.	1-0010	Pieza
3 mts.	1-0011	Pieza
4 mts.	1-0325	Pieza
5 mts.	1-0012	Pieza
6 mts.	1-0326	Pieza
8 mts.	1-0208	Pieza
10 mts.	1-0185	Pieza
15 mts.	1-0186	Pieza
20 mts.	1-0187	Pieza



EXTENSIÓN CALIBRE #16

BLANCA CCA

MEDIDA	CLAVE	INDIVIDUAL
1 m	1-0309	Pieza
2 mts.	5-110301	Pieza
3 mts.	5-110302	Pieza
4 mts.	5-110303	Pieza
5 mts.	5-110304	Pieza
6 mts.	5-110305	Pieza
8 mts.	5-110306	Pieza
10 mts.	5-110307	Pieza





LÍNEA DE PLACAS RESIDENCIAL

LÍNEA TRADICIONAL



**APAGADOR SENCILLO T/O
MARFIL / MATERIAL BAQUELITA**

CLAVE: 1-0013
INNER 50 / MASTER 1200



**APAGADOR SENCILLO T/O FOSFORADO
MARFIL / MATERIAL BAQUELITA**

CLAVE: 1-0014
INNER 50 / MASTER 1200



**APAGADOR ESCALERA T/O FOSFORADO
MARFIL / MATERIAL BAQUELITA**

CLAVE 1-0007
INNER 50 / MASTER 1200



**APAGADOR TIMBRE T/O
MARFIL / MATERIAL BAQUELITA**

CLAVE 1-0019
INNER 50 / MASTER 1200



**CONTACTO SENCILLO T/O
MARFIL / MATERIAL BAQUELITA**

CLAVE 1-0041
INNER 50 / MASTER 1200



**PLACA DORADA 1 UNIDAD
MATERIAL ALUMINIO**

CLAVE 6-0032
INNER 10 / MASTER 50



**PLACA DORADA 2 UNIDADES
MATERIAL ALUMINIO**

CLAVE 6-0033
INNER 10 / MASTER 50



**PLACA DORADA 3 UNIDADES
MATERIAL ALUMINIO**

CLAVE 6-0034
INNER 10 / MASTER 50



**PLACA DE ALUMINIO PILOTO
MATERIAL ALUMINIO**

CLAVE 6-0037
INNER 10 / MASTER 100



**PLACA DE ALUMINIO CIEGA
MATERIAL ALUMINIO / TIPO QUINZIÑO**

CLAVE 6-0036
INNER 10 / MASTER 100



**PLACA CIEGA
BLANCO / CUERPO ABS**

CLAVE 7-81604
PCA817 / INNER 30 / MASTER 600



**PLACA CIEGA
MARFIL
LÍNEA 2000 / PLÁSTICO ABS
CHASIS INTERNO METÁLICO GALVANIZADO**

CLAVE 21-ABSSCM
INNER 10 / MASTER 100



**PLACA CIEGA
BLANCA / LÍNEA 2000 / PLÁSTICO ABS
CHASIS INTERNO METÁLICO GALVANIZADO**

CLAVE 21-ABSSCB
INNER 10 / MASTER 100

LÍNEA TIPO MUELA MARFIL



**APAGADOR SENCILLO T/Q C/MUELAS
MARFIL
MATERIAL BAQUELITA**

**CLAVE 1-0043
INNER 20 / MASTER 600**



**APAGADOR DE ESCALERA T/Q C/MUELAS
MARFIL
MATERIAL BAQUELITA**

**CLAVE 1-0015
INNER 20 / MASTER 600**



**APAGADOR TIMBRE T/Q C/MUELAS
MARFIL
MATERIAL BAQUELITA**

**CLAVE 1-0166
INNER 20 / MASTER 600**



**CONTACTO SENCILLO T/Q CON MUELAS
MARFIL
MATERIAL BAQUELITA**

**CLAVE 1-0027
INNER 20 / MASTER 600**



**CONTACTO SENCILLO CON TIERRA Y MUELAS
MARFIL
MATERIAL BAQUELITA**

**CLAVE 1-0075
INNER 20 / MASTER 600**

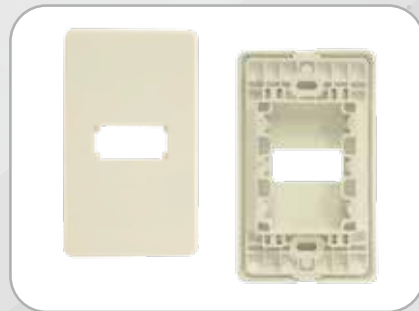

**PLACA 1-U
MARFIL
MATERIAL PLÁSTICO ABS**

**CLAVE 1-0072
INNER 20 / MASTER 240**



**PLACA 2-U
MARFIL
MATERIAL PLÁSTICO ABS**

**CLAVE 1-0073
INNER 20 / MASTER 240**

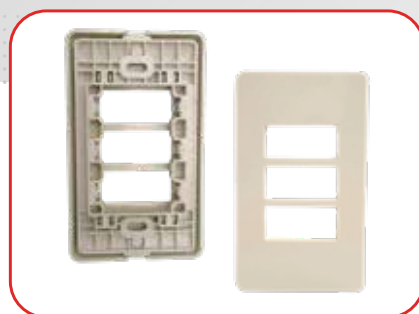

**PLACA 3-U
MARFIL
MATERIAL PLÁSTICO ABS**

**CLAVE 1-0074
INNER 20 / MASTER 240**

LÍNEA TIPO MUELA BLANCA



**APAGADOR SENCILLO T/Q
BLANCO
MATERIAL BAQUELITA
CON MUELAS**

**CLAVE 1-0472
INNER 20 / MASTER 600**



**APAGADOR DE ESCALERA T/Q
BLANCO
MATERIAL BAQUELITA
CON MUELAS**

**CLAVE 1-0473
INNER 20 / MASTER 600**



**APAGADOR TIMBRE T/Q
BLANCO
MATERIAL BAQUELITA
CON MUELAS**

**CLAVE 1-0474
INNER 20 / MASTER 600**



**CONTACTO SENCILLO T/Q CON MUELAS
BLANCO
MATERIAL BAQUELITA**

**CLAVE 1-0475
INNER 20 / MASTER 100**



**CONTACTO SENCILLO CON TIERRA Y MUELAS
BLANCO
MATERIAL BAQUELITA**

**CLAVE 1-0476
INNER 20 / MASTER 600**



**PLACA 1-U
BLANCO
MATERIAL PLÁSTICO ABS**

**CLAVE 1-0477
INNER 20 / MASTER 240**



**PLACA 2-U
BLANCO
MATERIAL PLÁSTICO ABS**

**CLAVE 1-0478
INNER 20 / MASTER 240**



**PLACA 3-U
BLANCO
MATERIAL PLÁSTICO ABS**

**CLAVE 1-0479
INNER 20 / MASTER 240**

LÍNEA EVO MARFIL



**APAGADOR SENCILLO
MARFIL**

**CLAVE 3-EEB-7024
INNER 20 / MASTER 1000**



**APAGADOR ESCALERA
MARFIL**

**CLAVE 3-EEB-7026
INNER 20 / MASTER 1000**



**BOTÓN TIMBRE
MARFIL**

**CLAVE 3-EEB-7022
INNER 20 / MASTER 1000**



**CONTACTO SENCILLO
MARFIL**

**CLAVE 3-EEB-7034
INNER 20 / MASTER 500**



**CONTACTO ARMADO P / EMPOTRAR
C/PLACA DUPLEX
MARFIL / MATERIAL ABS
CHASIS PLÁSTICO**

**CLAVE 1-0327
INNER 10 / MASTER 100**



**PLACA 1U
MARFIL
MATERIAL ABS
CHASIS PLÁSTICO**

**CLAVE 1-0336
INNER 20 / MASTER 240**

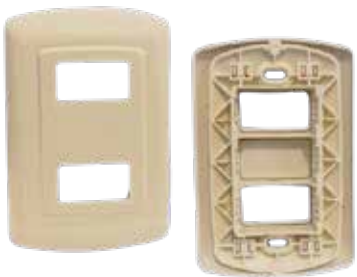

**PLACA 2U
MARFIL
MATERIAL ABS
CHASIS PLÁSTICO**

**CLAVE 1-0337
INNER 20 / MASTER 240**



**PLACA 3U
MARFIL
MATERIAL ABS
CHASIS PLÁSTICO**

**CLAVE 1-0338
INNER 20 / MASTER 240**



**PLACA CIEGA
MARFIL
MATERIAL ABS
CHASIS PLÁSTICO**

**CLAVE 22-E5N0
INNER 20 / MASTER 240**

LÍNEA EVO BLANCA



**APAGADOR SENCILLO
BLANCO**

**CLAVE 3-EEB-7024-B
INNER 20 / MASTER 1000**



**APAGADOR ESCALERA
BLANCO**

**CLAVE 3-EEB-7026-B
INNER 20 / MASTER 1000**



**BOTÓN TIMBRE
BLANCO**

**CLAVE 3-EEB-7022-B
INNER 20 / MASTER 1000**



**CONTACTO SENCILLO
BLANCO**

**CLAVE 3-EEB-7034-B
INNER 20 / MASTER 500**



**PLACA DUPLEX
BLANCA
MATERIAL ABS
CHASIS DE PLÁSTICO**

**CLAVE 1-0327-B
INNER 10 / MASTER 100**



**PLACA DE 1U
BLANCO
MATERIAL ABS
CHASIS DE PLÁSTICO**

**CLAVE 1-0336-B
INNER 20 / MASTER 240**



**PLACA DE 2U
BLANCO
MATERIAL ABS
CHASIS DE PLÁSTICO**

**CLAVE 1-0337-B
INNER 20 / MASTER 240**



**PLACA DE 3U
BLANCO
MATERIAL ABS
CHASIS DE PLÁSTICO**

**CLAVE 1-0338-B
INNER 20 / MASTER 240**



**PLACA CIEGA
BLANCA
MATERIAL ABS
CHASIS DE PLÁSTICO**

**CLAVE 22-E5N0-B
INNER 20 / MASTER 240**

LÍNEA 118



**APAGADOR SENCILLO PARA PLACA
LÍNEA 118
BLANCO
MATERIAL ABS**

**CLAVE 1-0109
INNER 20 / MASTER 600**



**APAGADOR ESCALERA PARA PLACA
MATERIAL PLÁSTICO
LÍNEA 118**

**CLAVE 1-0110
INNER 20 / MASTER 600**



**BOTÓN TIMBRE
LÍNEA 118
BOTÓN TIMBRE PARA PLACA
MATERIAL ABS**

**CLAVE 1-0111
INNER 20 / MASTER 600**



**CONTACTO SENCILLO PARA PLACA
MATERIAL PLÁSTICO
CONTACTO ATERRIZADO
LÍNEA 118**

**CLAVE 1-0112
INNER 20 / MASTER 600**



**PLACA CON 2 CONTACTOS
BLANCA
PLACA DE PLÁSTICO
MATERIAL ABS
CHASIS DE PLÁSTICO**

**CLAVE 1-L118-06
INNER 12 / MASTER 120**



**PLACA DE 1U
BLANCA
PLACA DE PLÁSTICO
MATERIAL ABS
CHASIS DE PLÁSTICO**

**CLAVE 1-0113
INNER 20 / MASTER 240**



**PLACA DE 2U
BLANCA
PLACA DE PLÁSTICO
MATERIAL ABS
CHASIS DE PLÁSTICO**

**CLAVE 1-0114
INNER 20 / MASTER 240**



**PLACA DE 3U
BLANCA
PLACA DE PLÁSTICO
MATERIAL ABS
CHASIS DE PLÁSTICO**

**CLAVE 1-0115
INNER 20 / MASTER 240**

LÍNEA MDX MARFIL



**APAGADOR SENCILLO
MARFIL
MATERIAL ABS**

**CLAVE 1-0399
INNER 20 / MASTER 1000**



**APAGADOR ESCALERA
MARFIL
MATERIAL ABS**

**CLAVE 1-0398
INNER 20 / MASTER 1000**



**BOTÓN TIMBRE
MARFIL
MATERIAL ABS**

**CLAVE 1-0407
INNER 20 / MASTER 1000**



**CONTACTO SENCILLO
MARFIL
MATERIAL ABS**

**CLAVE 1-0400
INNER 20 / MASTER 500**



**PLACA DUPLEX
MARFIL
MATERIAL ABS
CHASIS PLÁSTICO**

**CLAVE 1-0401
INNER 10 / MASTER 100**



**PLACA 1U
MARFIL
MATERIAL ABS
CHASIS PLÁSTICO**

**CLAVE 1-0402
INNER 20 / MASTER 240**



**PLACA 2U
MARFIL
MATERIAL ABS
CHASIS PLÁSTICO**

**CLAVE 1-0403
INNER 20 / MASTER 240**



**PLACA 3U
MARFIL
MATERIAL ABS
CHASIS PLÁSTICO**

**CLAVE 1-0404
INNER 20 / MASTER 240**

LÍNEA MDX BLANCA



**APAGADOR SENCILLO
BLANCO
MATERIAL ABS**

**CLAVE 1-0464
INNER 20 / MASTER 1000**



**APAGADOR ESCALERA
BLANCO
MATERIAL ABS**

**CLAVE 1-0465
INNER 20 / MASTER 1000**



**BOTÓN TIMBRE
BLANCO
MATERIAL ABS**

**CLAVE 1-0466
INNER 20 / MASTER 1000**



**CONTACTO SENCILLO
BLANCO
MATERIAL ABS**

**CLAVE 1-0467
INNER 20 / MASTER 500**



**CONTACTO DUPLEX CON PLACA
BLANCO
MATERIAL ABS
CHASIS PLÁSTICO**

**CLAVE 1-0468
INNER 10 / MASTER 100**



**PLACA 1U
BLANCO
MATERIAL ABS
CHASIS PLÁSTICO**

**CLAVE 1-0469
INNER 20 / MASTER 240**



**PLACA 2U
BLANCO
MATERIAL ABS
CHASIS PLÁSTICO**

**CLAVE 1-0470
INNER 20 / MASTER 240**



**PLACA 3U
BLANCO
MATERIAL ABS
CHASIS PLÁSTICO**

**CLAVE 1-0471
INNER 20 / MASTER 240**



**PLACA CIEGA
BLANCO
MATERIAL ABS**

**CLAVE 1-0480
INNER 20 / MASTER 240**

LÍNEA ARTLITE



**PLACA APAGADOR DE 1 INTERRUPTOR
BLANCA**
3 VÍAS / 90-260~50/60 Hz / 15A
MATERIAL POLICARBONATO
CON HIERRO GALVANIZADO

CLAVE 53-APL-201
INNER 10 / MASTER 100



**PLACA APAGADOR DE 2 INTERRUPTORES
BLANCA**
3 VÍAS / 90-260~50/60 Hz / 15A
MATERIAL POLICARBONATO
CON HIERRO GALVANIZADO

CLAVE 53-APL-202
INNER 10 / MASTER 100



**PLACA APAGADOR DE 3 INTERRUPTORES
BLANCA**
3 VÍAS / 90-260~50/60 Hz / 15A
MATERIAL POLICARBONATO
CON HIERRO GALVANIZADO

CLAVE 53-APL-203
INNER 10 / MASTER 100



**PLACA DE CONTACTO Y APAGADOR
DE 1 INTERRUPTOR / BLANCA**
3 VÍAS / APAGADOR 90-260~50/60 Hz
CONTACTO 90-260~50/60 Hz
15A / MATERIAL POLICARBONATO
CON HIERRO GALVANIZADO

CLAVE 53-APL-205
INNER 10 / MASTER 100



**PLACA DE CONTACTO Y APAGADOR
DE 2 INTERRUPTOR / BLANCA**
3 VÍAS / APAGADOR 90-260~50/60 Hz
CONTACTO 90-260~50/60 Hz
15A / MATERIAL POLICARBONATO
CON HIERRO GALVANIZADO

CLAVE 53-APL-206
INNER 10 / MASTER 100



**PLACA DE CONTACTO DOBLE
BLANCA**
3 VÍAS / 90-260~50/60 Hz / 15A
MATERIAL POLICARBONATO
CON HIERRO GALVANIZADO

CLAVE 53-APL-204
INNER 10 / MASTER 100



**PLACA DE CONTACTO Y 2 SALIDAS USB
BLANCA**
3 VÍAS / APAGADOR 90-277~50/60 Hz
USB IN 90-260~50/60 Hz / USB OUT 5V-MAX. 2.1A / 15A
MATERIAL POLICARBONATO CON HIERRO GALVANIZADO

CLAVE 53-APL-207
INNER 10 / MASTER 100

LÍNEA PREMIUM GRIS



PLACA CON INTERRUPTOR ESCALERA /
GRIS CUERPO DE ABS / LÍNEA 900
127V~ 60Hz 10 A / 72 mm

CLAVE 53-APL-101
INNER 15 / MASTER 150



PLACA CON 2 INTERRUPTORES DE ESCALERA / GRIS
CUERPO DE ABS / LÍNEA 900
127V~ 60Hz 10 A / 36 mm

CLAVE 53-APL-102
INNER 15 / MASTER 150



PLACA CON INTERRUPTOR TRIPLE DE ESCALERA / GRIS
CUERPO DE ABS / LÍNEA 900
127V~ 60Hz 10 A / 72 mm

CLAVE 53-APL-103
INNER 15 / MASTER 150



PLACA CON INTERRUPTOR DE ESCALERA Y
CONTACTO SENCILLO ATERRIZADO /GRIS / CUERPO DE ABS
LÍNEA 900 / INTERRUPTOR DE ESCALERA: 127V~ 60Hz 10 A
CONTACTO SENCILLO: 127V~ 60Hz 15 A / 36 mm

CLAVE 53-APL-105
INNER 15 / MASTER 150



PLACA CON CONTACTO DOBLE ATERRIZADO / GRIS
CUERPO DE ABS / LÍNEA 900
127V~ 60Hz 15 A / 36 mm

CLAVE 53-APL-104
INNER 15 / MASTER 150



PLACA CON CONTACTO USB
Y CONTACTO SENCILLO ATERRIZADO / GRIS / CUERPO DE ABS
LÍNEA 900 / CONTACTO USB: 127V~ 60Hz 5 Vcc 2100mA
CONTACTO SENCILLO: 127V~ 60Hz 15 A / 36 mm

CLAVE 53-APL-107
INNER 15 / MASTER 150

LINEA PREMIUN NEGRO MATE

PLACA NEGRA 1 APAGADOR DE 1 INTERRUPTOR 3 VÍAS

53- APL-301



01 JUL 2023



PLACA NEGRA 1 APAGADOR DE 2 INTERRUPTORES 3 VÍAS

53- APL-302

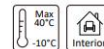

01 JUL 2023



ESPECIFICACIONES	
	PLACA NEGRA
	90-277~50/60 Hz
	15A
	75x118x33mm
	PESO: 53gr.
	POLICARBONATO+HIERRO GALV.
	ATENUADOR: NO
	OPERACIÓN: -10 A 40°C
	IP20

Placa negra de 1 interruptor 3 vías, con apagador de policarbonato y hierro galvanizado. Fácil de instalar, excelente calidad. Ideal para residencial, comercio y oficina.

ESPECIFICACIONES	
	PLACA NEGRA
	90-277~50/60Hz
	15A
	75x118x33mm
	PESO: 100gr.
	POLICARBONATO+HIERRO GALV.
	ATENUADOR: NO
	OPERACIÓN: -10 A 40°C
	IP20

Placa negra de 2 interruptores con apagador de policarbonato y hierro galvanizado. Fácil de instalar, excelente calidad. Ideal para residencial, comercio y oficina.

PLACA NEGRA APAGADOR DE 3 INTERRUPTORES 3 VÍAS

53- APL-303

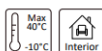

01 JUL 2023



ESPECIFICACIONES	
	PLACA NEGRA
	90-277~50/60 Hz
	15A
	75x118x33mm
	PESO: 122gr.
	POLICARBONATO+HIERRO GALV.
	ATENUADOR: NO
	OPERACIÓN: -10 A 40°C
	IP20

Placa negra de 3 interruptores con un apagador de policarbonato y hierro galvanizado. Fácil de instalar, excelente calidad. Ideal para residencial, comercio y oficina.

PLACA NEGRA DE CONTACTO DOBLE

53- APL-304

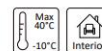

20 JUL 2023



ESPECIFICACIONES	
	PLACA NEGRA
	90-277~50/60 Hz
	15A
	75x118x33mm
	PESO: 97gr.
	POLICARBONATO+HIERRO GALV.
	ATENUADOR: NO
	OPERACIÓN: -10 A 40°C
	IP20

Placa negra de contacto doble de policarbonato y hierro galvanizado. Fácil de instalar, excelente calidad. Ideal para residencial, comercio y oficina.

PLACA NEGRA DE CONTACTO Y APAGADOR DE 1 INTERRUPTOR 3 VÍAS

53- APL-305



01 JUL 2023



ESPECIFICACIONES	
	PLACA NEGRA
	APAGADOR: 90-277~50/60 Hz
	CONTACTO: 90-277~50/60 Hz
	15A
	75x118x33mm
	PESO: 97gr.
	POLICARBONATO+HIERRO GALV.
	ATENUADOR: NO
	OPERACIÓN: -10 A 40°C
	IP20

Placa negro de un contacto y un apagador de policarbonato y hierro galvanizado. Fácil de instalar, excelente calidad. Ideal para residencial, comercio y oficina.

PLACA NEGRA DE CONTACTO Y 2 SALIDAS USB (TIPO A Y TIPO C)

53- APL-307



01 JUL 2023



ESPECIFICACIONES	
	PLACA NEGRA
	90-277~50/60 Hz
	USB IN: 90-260~50/60 Hz
	USB OUT: 5V $\overline{\text{M}}\overline{\text{A}}\overline{\text{X}}$. 2.1A
	15A
	75x118x40mm
	PESO: 111gr.
	POLICARBONATO+HIERRO GALV.
	ATENUADOR: NO
	OPERACIÓN: -10 A 40°C

Placa negra de un contacto y 2 entradas USB de policarbonato y hierro galvanizado. Fácil de instalar, excelente calidad. Ideal para residencial, comercio y oficina.

LINEA PREMIUN NEGRO MATE



PLACA NEGRA DE CONTACTO ATENUADOR ILUMINACIÓN MÁX. DE 100W

53-APL-311



01 JUL 2023

ESPECIFICACIONES

	PLACA NEGRA
	100-127V~50/60 Hz
	0.78A
	75x118x48mm
	PESO: 89gr.
	POLICARBONATO+HIERRO GALV.
	ATENUADOR: SI
	OPERACIÓN: -10 A 40°C
	IP20



Placa negra atenuador de policarbonato y hierro galvanizado. Fácil de instalar, excelente calidad. Ideal para residencial, comercio y oficina.

PLACA NEGRA TAPA CIEGA

53-APL-312

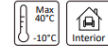

01 JUL 2023

ESPECIFICACIONES

	PLACA NEGRA
	75x118x9mm
	PESO: 89gr.
	POLICARBONATO+HIERRO GALV.
	ATENUADOR: NO
	OPERACIÓN: -10 A 40°C
	IP20



Placa negra de tapa ciega. Fácil de instalar, excelente calidad. Ideal para residencial, comercio y oficina.

PLACA NEGRA DE CONTACTO TIMBRE

53-APL-313



01 JUL 2023

ESPECIFICACIONES

	PLACA NEGRA
	90-127V~50/60 Hz
	15A
	75x118x33mm
	PESO: 80gr.
	POLICARBONATO+HIERRO GALV.
	ATENUADOR: NO
	OPERACIÓN: -10 A 40°C
	IP20



Placa negra de policarbonato y hierro galvanizado. Fácil de instalar, excelente calidad. Ideal para residencial, comercio y oficina.

Placas Premium Color Negro



Salida USB

APL-307



LINEA ACRILICO ZOLAR



2-L-A38-B	PLACA ACRILICA BLANCA C/1 APAGADOR 72 MM
2-L-A38-A	PLACA ACRILICA AQUA C/1 APAGADOR 72 MM
2-L-A38-G	PLACA ACRILICA GRIS C/1 APAGADOR 72 MM
2-L-A39-B	PLACA ACRILICA BLANCA C/2 APAGADORES 36 MM
2-L-A39-A	PLACA ACRILICA AQUA C/2 APAGADORES 36 MM
2-L-A39-G	PLACA ACRILICA GRIS C/2 APAGADORES 36 MM
2-L-A40-B	PLACA ACRILICA BLANCA C/3 APAGADORES 24 MM
2-L-A40-A	PLACA ACRILICA AQUA C/3 APAGADORES 24 MM
2-L-A40-G	PLACA ACRILICA GRIS C/3 APAGADORES 24 MM
2-L-C31-B	PLACA ACRILICA BLANCA C/2 CONTACTOS 36MM
2-L-C31-A	PLACA ACRILICA AQUA C/2 CONTACTOS 36MM
2-L-C31-G	PLACA ACRILICA GRIS C/2 CONTACTOS 36MM
2-LAC-04-B	PLACA ACRILICA BCA C/1 APAGADOR 1 CONTACTO 36 MM
2-LAC-04-A	PLACA ACRILICA AQUA C/1 APAGADOR 1 CONTACTO 36 MM
2-LAC-04-G	PLACA ACRILICA GRIS C/1 APAGADOR 1 CONTACTO 36 MM
2-LAC-05-B	PLACA ACRILICA BCA C/1 APAGADOR 2 CONTACTO 24 MM
2-LAC-05-A	PLACA ACRILICA AQUA C/1 APAGADOR 2 CONTACTO 24 MM
2-LAC-05-G	PLACA ACRILICA GRIS C/1 APAGADOR 2 CONTACTO 24 MM
2-LAC-06-B	PLACA ACRILICA BCA C/2 APAGADOR 1 CONTACTO 24 MM
2-LAC-06-A	PLACA ACRILICA AQUA C/2 APAGADOR 1 CONTACTO 24 MM
2-LAC-06-G	PLACA ACRILICA GRIS C/2 APAGADOR 1 CONTACTO 24 MM

LINEA BLANCA WINLED

PLACA APAGADOR DE 1 INTERRUPTOR 3 VÍAS

WPL-301



Feb. 2023

WINLED
Más que Iluminación

ESPECIFICACIONES

	PLACA
	90-260~50/60 Hz
	15A
	70x115mm
	PESO: 41 gr.
	ABS
	ATENUABLE: NO
	OPERACIÓN: -10 A 40°C



PLACA APAGADOR DE 2 INTERRUPTORES 3 VÍAS

WPL-302



Feb. 2023

WINLED
Más que Iluminación

ESPECIFICACIONES

	PLACA
	90-277~50/60 Hz
	15A
	70x115mm
	PESO: 52gr.
	ABS
	ATENUABLE: NO
	OPERACIÓN: -10 A 40°C



PLACA APAGADOR DE 3 INTERRUPTORES 3 VÍAS

WPL-303



Feb. 2023

WINLED
Más que Iluminación

ESPECIFICACIONES

	PLACA
	90-277~50/60 Hz
	15A
	70x115mm
	PESO: 59 gr.
	ABS
	ATENUABLE: NO
	OPERACIÓN: -10 A 40°C



PLACA DE CONTACTO DOBLE

WPL-304



Feb. 2023

WINLED
Más que Iluminación

ESPECIFICACIONES

	PLACA
	90-277~50/60 Hz
	15A
	70x115mm
	PESO: 55 gr.
	ABS
	ATENUABLE: NO
	OPERACIÓN: -10 A 40°C



PLACA DE CONTACTO Y APAGADOR DE 1 INTERRUPTOR 3 VÍAS

WPL-305



Feb. 2023

WINLED
Más que Iluminación

ESPECIFICACIONES

	PLACA
	APAGADOR: 90-277~50/60 Hz
	CONTACTO: 90-277~50/60 Hz
	15A
	70x115mm
	PESO: 55 gr.
	ABS
	ATENUABLE: NO



PLACA DE CONTACTO Y DOS SALIDAS USB SALIDA TIPO C Y TIPO A

WPL-307



Feb. 2023

WINLED
Más que Iluminación

ESPECIFICACIONES

	PLACA
	90-277~50/60 Hz
	USB ENTRADA: 90-277~50/60Hz
	USB SALIDA: 5V MÁX. 2.1A
	15A
	77x115mm
	PESO: 74 gr.
	ABS.
	ATENUABLE: NO



PLACA DE CONTACTO TIMBRE WPL-313

WPL-313

WINLED
Más que Iluminación

ESPECIFICACIONES

💡	PLACA
⚡	90-127V 50/60 Hz
🌀	15A
📏	70x115mm
📖	PESO: 40 gr.
💎	ABS
🔊	ATENUABLE: NO
🌡️	OPERACIÓN: -10 A 40°C
💧	IP20

DIAGRAMA DE CONEXIÓN

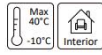

Feb 2023



PLACA TAPA CIEGA WPL-312

WPL-312

WINLED
Más que Iluminación

ESPECIFICACIONES

💡	PLACA
⚡	N/A
🌀	N/A
📏	70x115mm
📖	PESO: 28 gr.
💎	ABS
🔊	ATENUABLE: NO
🌡️	OPERACIÓN: -10 A 40°C
💧	IP20

DIAGRAMA DE CONEXIÓN

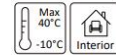

Feb 2023



PLACA DE CONTACTO ATENUADOR ILUMINACIÓN DE 100W

WPL-311

WINLED
Más que Iluminación

ESPECIFICACIONES

💡	PLACA
⚡	100-127V~50/60 Hz
🌀	0.78 A
📏	70x115mm
📖	PESO: 60 gr.
💎	ABS
🔊	ATENUABLE: NO
🌡️	OPERACIÓN: -10 A 40°C
💧	IP20

DIAGRAMA DE CONEXIÓN

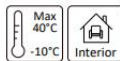

Feb 2023





ILUMINACIÓN



CLAVE	DESCRIPCION
60-001	FOCO LED JDR 7W L.D. 450 LUMENS INNER 10/ MASTER 100
60-002	FOCO LED JDR 7W CALIDO 430 LUMENS INNER 10/ MASTER 100
60-003	FOCO LED GU-10 7W L.D. 450 LUMENS INNER 10/ MASTER 100
60-004	FOCO LED GU-10 7W CALIDO 430 LUMENS INNER 10/ MASTER 100
60-005	FOCO LED MR-16 7W L.D. 450 LUMENS INNER 10/ MASTER 100
60-006	FOCO LED MR-16 7W CALIDO 430 LUMENS INNER 10/ MASTER 100



GRADO DE APERTURA 38°



E-14



E-27



E-12

CLAVE	DESCRIPCION
60-007	FOCO LED VELA 4W E-12 L.D. 280 LUMENS
60-008	FOCO LED VELA 4W E-12 CALIDO 280 LUMENS
60-009	FOCO LED VELA 4W E-14 L.D. 280 LUMENS
60-010	FOCO LED VELA 4W E-14 CALIDO 280 LUMENS
60-011	FOCO LED VELA 4W E-27 L.D. 280 LUMENS
60-012	FOCO LED VELA 4W E-27 CALIDO 280 LUMENS

FOCO A-13 5W



CLAVE	DESCRIPCION
60-013	FOCO 5W L.D. 440 LM E-27
60-014	FOCO 5W CALIDO 400 LM E-27

INNER 10PZAS / MASTER 100PZAS



PANEL AJUSTABLE

CLAVE	DESCRIPCION
56-001	8W 115MM L.D. C/100
56-002	15W 172MM L.D. C/40
56-003	20W 230MM L.D. C/20



ASPIRINA AJUSTABLE

CLAVE	DESCRIPCION
56-004	10W 35MM L.D. C/100
56-005	15W 120MM L.D. C/60
56-006	22W 170MM L.D. C/20
56-014	32W 210MM L.D. C/20



SOBREPONER

CLAVE	DESCRIPCION
56-007	12W 115MM L.D. C/20
56-008	18W 204MM L.D. C/20
56-009	24W 280MM L.D. C/20
56-010	12W 115MM CALIDA C/20
56-011	18W 204MM CALIDA C/20
56-012	24W 280MM CALIDA C/20



IMPORTACION



CLAVE	DESCRIPCION
56-013	PANEL SLIM 9W L.D. C/40 PZAS



CLAVE	DESCRIPCION
56-015	REFLECTOR 20 W C/50 PZAS
56-016	REFLECTOR 30 W C/30 PZAS
56-017	REFLECTOR 50 W C/20 PZAS
56-018	REFLECTOR 100 W C/10 PZAS



CLAVE	DESCRIPCION
56-019	REGLETA 24 W L.D. 1920LM C/30 PZAS
56-020	REGLETA 30 W L.D. 2750LM C/30 PZAS



CLAVE	DESCRIPCION
56-021	REGLETA DE 48W 3840 LM L.D. 1.20 CM C/30
56-022	REGLETA DE 72W 5120 LM L.D. 1.20 CM C/30





CLAVE	DESCRIPCION
56-023	FOCO BALA 28W L.D. C/25
56-024	FOCO BALA 38W L.D. C/25
2-ZL-FB-30W	FOCO BALA 30W L.D. ZOLAR
1-0153	FOCO BALA 50W L.D. ZOLAR
2-ZL-FB-50W	FOCO BALA 50W L.D. GDE ZOLAR



ASPIRINA SOBREPONER

CLAVE	DESCRIPCION
56-025	ASPIRINA DE SOBREPONER 18W L.D. C/20
56-026	ASPIRINA DE SOBREPONER 24W L.D. C/20
56-027	ASPIRINA DE SOBREPONER 36W L.D. C/10
56-028	ASPIRINA DE SOBREPONER 48W L.D. C/10

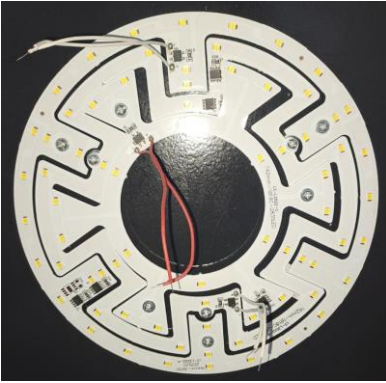

CLAVE	DESCRIPCION
39-GA0321	REPUESTO LED 12W
39-GA0322	REPUESTO LED 15W
39-GA0323	REPUESTO LED 20W
39-T8U435-19	TUBO LED 19W ALUMINIO LUZ FRIA

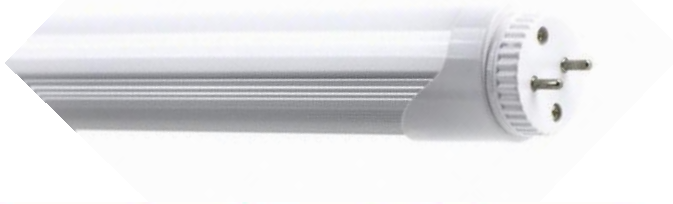

Decorativo de Pared ó Techo



FOCOS Y MÓDULOS LED



*** LÁMPARA LED GU10**
LUZ CÁLIDA / 7 WATTS
127V~ 60Hz / 480 lm / 3000 K

CLAVE 5-121051
INNER 10 / MASTER 60

*** LÁMPARA LED GU10**
LUZ BLANCA / 7 WATTS
127V~ 60Hz / 500 lm / 6500 K

CLAVE 5-121021
INNER 10 / MASTER 60



*** LÁMPARA LED MR16**
LUZ CÁLIDA
7 WATTS
127V~ 60Hz / 480 lm / 3000 K

CLAVE 5-121053
INNER 10 / MASTER 60

*** LÁMPARA LED MR16**
LUZ BLANCA
7 WATTS
127V~ 60Hz / 500 lm / 6500 K

CLAVE 5-121023
INNER 10 / MASTER 60



*** LÁMPARA LED JDR E27**
LUZ CÁLIDA
7 WATTS
127V~ 60Hz / 480 lm / 3000 K

CLAVE 5-121055
INNER 10 / MASTER 60

*** LÁMPARA LED JDR E27**
LUZ BLANCA
7 WATTS
127V~ 60Hz / 500 lm / 6500 K

CLAVE 5-121025
INNER 10 / MASTER 60

**NO USAR EN LUGARES HÚMEDOS. / DISEÑADO PARA USO INTERIOR.
NO USAR EN COMBINACIÓN CON REGULADORES DE INTENSIDAD LUMINOSA O FOTOCELDAS.*



LÁMPARA LED TIPO PAR20
E27 / LUZ BLANCA / 6 WATTS
127V~ 60Hz / 490 lm / 6500 K
USO INTERIOR

CLAVE 5-115543
INNER 6 / MASTER 12

LÁMPARA LED TIPO PAR20
E27 / LUZ CÁLIDA / 6 WATTS
127V~ 60Hz / 460 lm / 3000 K
USO INTERIOR

CLAVE 5-115544
INNER 6 / MASTER 12



LÁMPARA LED TIPO PAR30
E27 / LUZ CÁLIDA / 12 WATTS
127V~ 60Hz / 460 lm / 3000 K
USO INTERIOR

CLAVE 5-115566
INNER 6 / MASTER 12

LÁMPARA LED TIPO PAR30
E27 / LUZ BLANCA / 12 WATTS
127V~ 60Hz / 490 lm / 6500 K
USO INTERIOR

CLAVE 5-115565
INNER 6 / MASTER 12



TIRA DE LED RGB PIXEL IP65 5MTS
INCLUYE ELIMINADOR, CONTROL, AUDIO RITMICA.
SE PUEDE MANEJAR CON APLICACION
CLAVE 1-60059



FOCO LED / ECONOMICO
LUZ DE DÍA

10 WTS
CLAVE 22-B03W10

INNER 10 PZA / MASTER 100



*** LÁMPARA LED TIPO VELA**
E12 / LUZ CÁLIDA / 4 WATTS
127V~ 60Hz / 280 lm / 3000 K

CLAVE 5-122001
INNER 10 / MASTER 60

*** LÁMPARA LED TIPO VELA**
E12 / LUZ BLANCA / 4 WATTS
127V~ 60Hz / 280 lm / 6500 K

CLAVE 5-122012
INNER 10 / MASTER 60

*** LÁMPARA LED TIPO VELA**
E27 / LUZ CÁLIDA / 4 WATTS
127V~ 60Hz / 280 lm / 3000 K

CLAVE 5-122003
INNER 10 / MASTER 60

*** LÁMPARA LED TIPO VELA**
E27 / LUZ BLANCA / 4 WATTS
127V~ 60Hz / 280 lm / 6500 K

CLAVE 5-122014
INNER 10 / MASTER 60

***NO USAR EN LUGARES HÚMEDOS. / DISEÑADO PARA USO INTERIOR.**
NO USAR EN COMBINACIÓN CON REGULADORES DE INTENSIDAD LUMINOSA O FOTOCELAS.

FOCO LED A-15 E26 5W

BLANCO FRÍO / BLANCO CÁLIDO

CLAVE: 52-WLA-001 **BF**

52-WLA-008 **BC**

WINLED
Más que Iluminación

ESPECIFICACIONES

 LÁMPARA LED/E26

 5 WATTS

 100-140V ~50-60Hz

 FP: > 0.5

 430 LÚMENES

 360° APERTURA: 220°

 3000K - BLANCO CÁLIDO
6500K - BLANCO FRÍO

 IRC - REND. COLOR >70

 SMD 2835

 D. 50x85mm

 PESO: 50gr.

 ALUMINIO + PLÁSTICO + PC

 ATENUABLE: NO

 OPERACIÓN: -10 A 40°C

 IP20

INNER PZA / MASTER 50

VIDA ÚTIL: 30,000



Funciona perfectamente para espacios amplios como salas, oficinas, cocinas, etc. Su diseño innovador incluye material de aluminio + plástico + pc para una óptima disipación térmica.

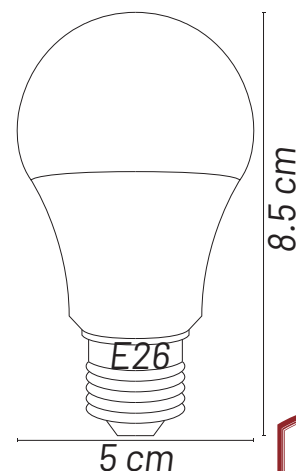
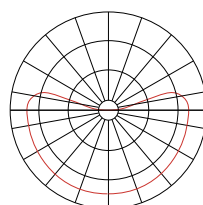
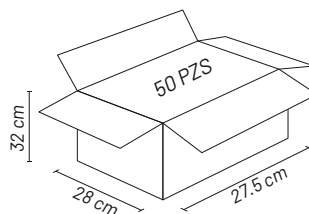

FOCO LED A19 LED LUZ BLANCA / LUZ CÁLIDA

CLAVE: 5-120025 BF BC **9 WTS**

CLAVE: 5-120027 BF BC **12 WTS**

CLAVE: 5-120029 BF BC **15 WTS**

ESPECIFICACIONES

W CONSUME 9 WATTS
ILUMINA 60 WATTS

 127 V \equiv

 750 LÚMENES
800 LÚMENES

W CONSUME 12 WATTS
ILUMINA 75 WATSS

 1100 LÚMENES
1050 LÚMENES

 60° OMNIDIRECCIONAL: 240°

 3 3000K BLANCO CÁLIDO
6500K BLANCO FRÍO

 CAJA

 6X11 CM

INNER PZA / MASTER 40

VIDA ÚTIL: 15,000



BASE E27



NOM

CUMPLE LOS PARÁMETROS DE LA NOM-030- EHER-2016



**FOCO BALA CON SENSOR
LUZ DE DIA**

CLAVE: 5-116426 20WTS

CLAVE: 5-116427 30WTS

CLAVE: 5-116428 40WTS

CLAVE: 5-116429 50WTS



AKSI Lighting

Lámpara LED con
SENSOR DE MOVIMIENTO
Alta Potencia tipo T

50 Watts
Luz blanca

Contamos con:
20, 30 y 40 watts

Excelente para iluminar:
Entradas, Escaleras, Sotanos,
Cocheras. Pasillos, Bodegas.

•No utilizar en lugares húmedos.
•Diseñado para interiores.

aksi.com.mx

5m
Distancia máxima de detección

SENSOR DE MOVIMIENTO

NOM

FOCOS FILAMENTO



FOCO FILAMENTO AZUL
A19 4W

CLAVE 5-122222
INNER 6 / MASTER 36



FOCO FILAMENTO ROJO
A19 4W

CLAVE 5-122223
INNER 6 / MASTER 36



FOCO FILAMENTO VERDE
A19 4W

CLAVE 5-122224
INNER 6 / MASTER 36



FOCO FILAMENTO AMARILLO
A19 4W

CLAVE 5-122225
INNER 6 / MASTER 36



FOCO FILAMENTO LILA
A19 4W

CLAVE 5-122226
INNER 6 / MASTER 36

MÓDULO 3 LED SMD 5050 MÁX. 0.72W RGB MULTICOLOR

CLAVE: 52-WM0-001

ESPECIFICACIONES

	ATENUABLE: SI (*OPCIONAL)
	MÁX. 0.72 WATTS
	12V ===
	IRC - REND. COLOR > 70
	15-40 LÚMENES
	APERTURA: 120°
	RGB - MULTICOLOR
	OPERACIÓN: -10 A 40°C
	EPISTAR SMD 5050
	75x15x5mm
	IP65
	PLÁSTICO + POLICARBONATO
	INNER 20 / MASTER 100
	VIDA ÚTIL: 30,000

WINLED
Más que Iluminación



***REQUIERE UN ATENUADOR**



Su aplicación permite recrear iluminación indirecta para diferentes espacios. La protección IP65 es resistente al polvo y agua, perfecta para exteriores (no sumergible).

MÓDULO DE 3xLED SMD2835 1.6W BLANCO FRÍO / BLANCO CÁLIDO

CLAVE: 52-WM0-020 **BF**

52-WM0-021 **BC**

ESPECIFICACIONES

	ATENUABLE: NO
	1.6 WATTS
	110-135 V ~50/60 Hz
	115 LÚMENES
	APERTURA: 120°
	IRC - REND. COLOR > 80
	3000K BLANCO CÁLIDO 6500K BLANCO FRÍO
	3xSMD 2835
	PLÁSTICO + POLICARBONATO
	IP67
	INNER 10 / MASTER 100
	VIDA ÚTIL: 30,000

WINLED
Más que Iluminación



Bajo consumo energético: ahorra hasta un 80% comparado con lámparas incandescentes.

Su aplicación permite recrear iluminación indirecta para diferentes espacios. Trabajan de 2 en 2.



CONTROLADOR TIRA RGB CON CONTROL DE 16 COLORES MÁX. 72W

CLAVE: 52-WAC-001

ESPECIFICACIONES	
	ACCESORIO
	72 WATTS
	12V ===
	50x35x22mm
	PESO: 20gr.
	PLÁSTICO
	ATENUABLE: SI
	OPERACIÓN: -10 A 40°C
	IP20
VIDA ÚTIL: 30,000 h	

WINLED
Más que Iluminación

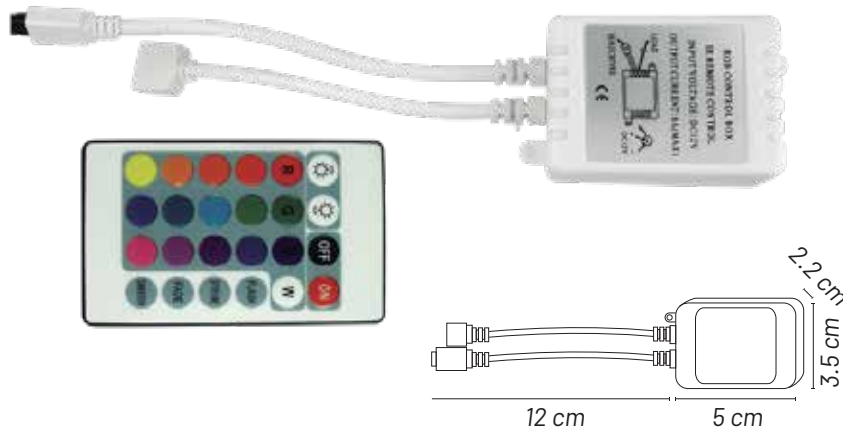

El control remoto tiene 16 colores, encendido, apagado, 4 programas y atenuador.

ELIMINADOR DE VOLTAJE 24W CD 12V A 2AMP INTERIOR

CLAVE: 52-WEL-001

ESPECIFICACIONES	
	ELIMINADOR
	24 WATTS
	90-260V~ 50/60 Hz
	SALIDA: 12V==@2.00A
	82x45x30mm
	PESO: 95gr
	PLÁSTICO
	ATENUABLE: NO
	OPERACIÓN: -10 A 40°C
	IP20
VIDA ÚTIL: 30,000	

WINLED
Más que Iluminación

N/A



Se puede utilizar para cámaras de videovigilancia, monitores, etc. se recomienda dejar espacio suficiente con ventilación para disipar el calor.
Medida del cable: 150 cm



REFLECTOR



REFLECTOR LED SMD WINLED

52-WRE-009 20W 1,700 LM

52-WRE-012 30W 2,550 LM

52-WRE-013 50W 4,250 LM

52-WRE-014 100W 9,000 LM

IP65

REFLECTOR LED SMD ARTLITE

53-ARE-025 300W 37,500 LM

53-ARE-026 400W 50,000 LM

53-ARE-027 500W 62,500 LM

IP66



LAMPARA VENTILADOR

MODELO: 2-GD-B162



ENERGÍA AMIGABLE CON EL MEDIO AMBIENTE

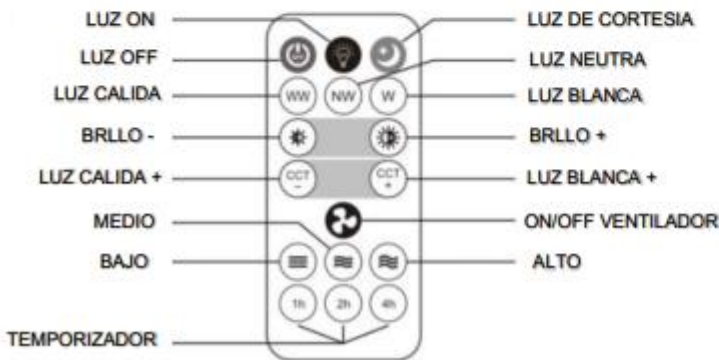

COLORES DISPONIBLES

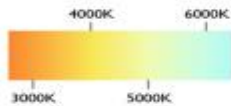

POTENCIA: 30 W
ESPECIFICACIONES ELECTRICAS: 125/250V~
90 lm/watt
MATERIAL: PVC
50,000 HORAS DE VIDA UTIL
ENTRADA: E27
COLOR DE LA LUZ: BLANCA, NEUTRA Y CALIDA
IP 20
MEDIDAS: DIAMETRO 25 CM Y ALTO 11 CM
NUMERO DE ASPAS: 5
PESO: 0.7 KG
VENTILADOR DE 3 VELOCIDADES



PALERMO



12W 26CM 1,200LM CLAVE 37-1125
 15W 26CM 1,500LM CLAVE 37-1126
 18W 34CM 1,800LM CLAVE 37-1127

MILAN



12W 26CM 1,200LM CLAVE 37-1135
 15W 26CM 1,500LM CLAVE 37-1123
 18W 34CM 1,800LM CLAVE 37-1124

MASTER 10 PZAS

FLORENCIA



12W 26CM 1,200LM CLAVE 37-1117
 15W 26CM 1,500LM CLAVE 37-1118
 18W 34CM 1,800LM CLAVE 37-1119

FERRERA



12W 26CM 1,200LM CLAVE 37-1132
 15W 26CM 1,500LM CLAVE 37-1133
 18W 34CM 1,800LM CLAVE 37-1134

MASTER 10 PZAS

BARCELONA



12W 26CM 1,200LM CLAVE 37-1098
 15W 26CM 1,500LM CLAVE 37-1099
 18W 34CM 1,800LM CLAVE 37-1100

MADRID



12W 26CM 1,200LM CLAVE 37-1095
 15W 26CM 1,500LM CLAVE 37-1096
 18W 34CM 1,800LM CLAVE 37-1097

MASTER 10 PZAS

**NO USAR EN LUGARES HÚMEDOS. / DISEÑADO PARA USO INTERIOR.
 NO USAR EN COMBINACIÓN CON REGULADORES DE INTENSIDAD LUMINOSA O FOTOCELIDAS.*

FOCOS INCANDESCENTES



FOCO 7 1/2 CLARO COLOR
5 COLORES DIFERENTES
E-12 / 127V~ 60Hz / 5W
CASQUILLO GALVANIZADO / FILAMENTO REFORZADO

CLAVE 4-04103
INNER 50 / MASTER 1000



FOCO VELA CLARO
C-32 E12 127V~60Hz / CASQUILLO DE ALUMINIO GALVANIZADO
FILAMENTO REFORZADO / BAJO CONSUMO DE ENERGÍA
LUZ FLAMA DECORATIVA

25 W CLAVE 4-03403 / 40 W CLAVE 4-03404
SANTUL **37-2146**
INNER 10 / MASTER 100



FOCO 7 1/2 SIN COLOR
E-12 / 127V~ 60Hz / 5W / CASQUILLO GALVANIZADO
FILAMENTO REFORZADO

CLAVE 4-04105
INNER 50 / MASTER 1000



FOCO REFRIGERADOR
E-26 40W / ILUMINA 370 lm

CLAVE 50-92-9454
INNER 10 / MASTER 100

FOCOS INCANDESCENTES



FOCO FIESTA ÁMBAR
FOCO BULBO / E-26 40W
CASQUILLO ALUMINIO GALVANIZADO
FILAMENTO REFORZADO

CLAVE 4-04002
INNER 10 / MASTER 100



FOCO FIESTA AZUL
FOCO BULBO / E-26 40W
CASQUILLO ALUMINIO GALVANIZADO
FILAMENTO REFORZADO

CLAVE 4-04003
INNER 10 / MASTER 100



FOCO FIESTA VERDE
FOCO BULBO / E-26 40W
CASQUILLO ALUMINIO GALVANIZADO
FILAMENTO REFORZADO

CLAVE 4-04004
INNER 10 / MASTER 100



FOCO FIESTA PÚRPURA
FOCO BULBO / E-26 40W
CASQUILLO ALUMINIO GALVANIZADO
FILAMENTO REFORZADO

CLAVE 4-04005
INNER 10 / MASTER 100



FOCO FIESTA ROJO
FOCO BULBO / E-26 40W
CASQUILLO ALUMINIO GALVANIZADO
FILAMENTO REFORZADO

CLAVE 4-04006
INNER 10 / MASTER 100



FOCO FIESTA BLANCO
FOCO BULBO / E-26 40W
CASQUILLO ALUMINIO GALVANIZADO
FILAMENTO REFORZADO

CLAVE 4-04007
INNER 10 / MASTER 100

LÁMPARAS



**LAMPARITA DE CASITA
VERDE
ROSA**

**CLAVE 1-OSP-219
INNER PZA / MASTER 40**



**LAMPARITA DE POLLITO
AMARILLO
CON SENSOR DE MOVIMIENTO**

**CLAVE 1-OSP-221
INNER PZA / MASTER 30**



**LAMPARITA DE NUBE
VERDE
ROSA
AMARILLO**

**CLAVE 1-OSP-301
INNER PZA / MASTER 40**

MINI LÁMPARAS



LAMPARITA DE BALÓN
ROJO
AZUL
VERDE
NEGRO

CLAVE 1-OSP-308
INNER PZA / MASTER 40



LAMPARITA DE PERRITO
AZUL
BLANCO
VERDE
ROSA

CLAVE 1-OSP-330
INNER PZA / MASTER 40



LAMPARITA DE FLOR
VERDE
ROSA
AMARILLO
AZUL

CLAVE 1-OSP-305
INNER PZA / MASTER 40



LAMPARITA DE FAROLITO
ROSA
VERDE
NARANJA
AMARILLO

CLAVE 1-OSP-314
INNER PZA / MASTER 40

EMPOTRABLE DIRIGIBLE ARO METÁLICO COLOR SATÍN MÁX. 50W

CLAVE: NEGRA 53- ADE-104
CLAVE: BLANCA 53- ADE-105
CLAVE: SATÍN 53- ADE-106

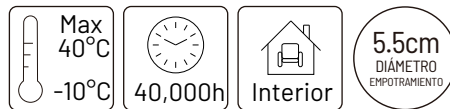

ESPECIFICACIONES

	DECORATIVO
	MÁX. 50W
	90-260~ 50/60Hz
	N/A
	N/A
	APERTURA: MÁX.120°
	N/A
	N/A
	BASE MR16
	D.89x28mm
	PESO: 5gr.
	METAL
	ATENUABLE: NO
	OPERACIÓN: -10 A 40°C
	IP20

INNER PZA / MASTER 100

VIDA ÚTIL: 40,000



El complemento decorativo para lámpara MR16.
En un elegante color satín, con la posibilidad de ser dirigido.

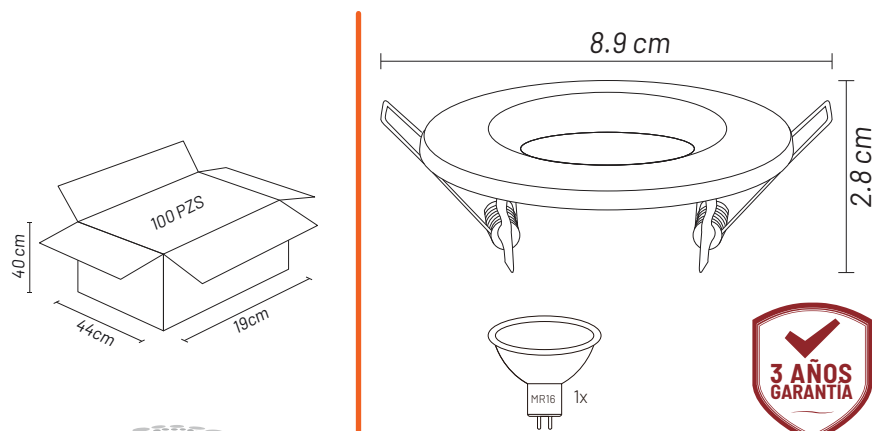

REFLECTORES SOLARES



REFLECTOR SOLAR 60W
USO EXTERIOR / LED SMD 5730 / 100 Lm/Watt
ÁNGULO DE ILUMINACIÓN 120° / 6000K LUZ BLANCA
TIEMPO DE CARGA 8 HRS
PANEL SOLAR DE SILICON MONOCRISTALINO / BATERÍA DE LITIO

CLAVE 1-0720
CODIGO ZL-RS-60W
INNER PZA / MASTER 5



REFLECTOR SOLAR 150W
USO EXTERIOR / 100 Lm/Watt
ÁNGULO DE ILUMINACIÓN 120° / 6000K LUZ BLANCA
TIEMPO DE CARGA 8 HRS
PANEL SOLAR DE SILICÓN MONOCRISTALINO
BATERÍA DE HIERRO FERRICO

CLAVE 1-0723
CODIGO ZL-RS-150W
INNER PZA



REFLECTOR SOLAR 200W
USO EXTERIOR / 100 Lm/Watt
ÁNGULO DE ILUMINACIÓN 120° / 6000K LUZ BLANCA
TIEMPO DE CARGA 8 HRS
PANEL SOLAR DE SILICÓN MONOCRISTALINO
BATERÍA DE HIERRO FERRICO

CLAVE 1-0724
CODIGO ZL-RS-200W
INNER PZA



SEGURIDAD CFE

FUSIBLES



**CARTUCHO FUSIBLE REFORZADO
30 AMP**

**CLAVE 1-0167
INNER 10 / MASTER 500**



**CARTUCHO FUSIBLE KITA-FÁCIL
30 AMP**

**CLAVE 1-0117
INNER 10 / MASTER 500**



**CARTUCHO REFORZADO GAMMA
30 AMP**

**CLAVE 9-001
INNER 10 / MASTER 500**

FUSIBLES



**CARTUCHO FUSIBLE KITA-FÁCIL GAMMA
30 AMP**

CLAVE 9-003
INNER 10 / MASTER 200



**CARTUCHO REFORZADO GAMMA
60 AMP**

CLAVE 9-002
INNER 10 / MASTER 100



**CARTUCHO FUSIBLE
KITA-FÁCIL
60 AMP**

CLAVE 9-011
INNER 10 / MASTER 200



**CARTUCHO FUSIBLE
60 AMP**

CLAVE 9-006
INNER 10 / MASTER 200



LISTÓN FUSIBLE 30 AMP. C/40 PZAS.

CLAVE 4-01007
INNER 5 / MASTER 20



**LISTÓN FUSIBLE 60 AMP C/40 pz
125/250V~**

CLAVE 9-008
INNER 5 / MASTER 20



**TAPÓN FUSIBLE IUSA
30 AMP**

**CLAVE 1-310718
INNER 5 / MASTER 100**



INTERRUPTOR TERMOMAGNÉTICO

- BIOMETÁLICO (TÉRMICO)
- CONTACTOS INTERNOS DE LATÓN
- CUERPO DE BAQUELITA DE ALTA RESISTENCIA

AMP	CLAVE	SANELEC
15 AMP	1-0058	37-4337
20 AMP	1-0059	37-4338
30 AMP	1-0060	37-4339
40 AMP	1-0183	37-4340

INNER 10 / MASTER 100



BASE PARA MEDIDOR

**CLAVE 9-013
INNER 1 / MASTER 30**

**ACCESORIO PARA ALOJAR EL MEDIDOR
DE CONSUMO ELÉCTRICO.**

- CUERPO INYECTADO EN ALUMINIO.
- BASES DE POLICARBONATO TÉCNICO TRANSPARENTE SEGÚN NORMA CFE.
- MORDAZAS DE COBRE CON RECUBRIMIENTO DE PLATA Y MUELLE REFORZADO QUE GARANTIZA UN EXCELENTE CONTACTO.
- ZAPATAS TERMINALES PARA CONDUCTOR DE COBRE O ALUMINIO.
- SERVICIO MONOFÁSICO.
- 100 AMP.
- NEMA 3R.

**UTILIZADA EN ÁREAS RESIDENCIALES
Y COMERCIALES 600V. MÁX. 100 AMP.**

NORMAS:

**FABRICADA SOBRE LA NORMA CFEGWH00-11
DE COMISIÓN FEDERAL DE ELECTRICIDAD.**

CENTROS DE CARGA



**CENTRO DE CARGA
1 UNIDAD
EMPOTRAR**

CLAVE 1-0357
INNER 1 / MASTER 15



**CENTRO DE CARGA
1 UNIDAD
SOBREPONER**

CLAVE 1-0358
INNER 1 / MASTER 15



**CENTRO DE CARGA
2 UNIDADES
EMPOTRAR**

CLAVE 1-0359
INNER 1 / MASTER 10



**CENTRO DE CARGA
2 UNIDADES
SOBREPONER**

CLAVE 1-0360
INNER 1 MASTER 10



**CENTRO DE CARGA
4 UNIDADES
EMPOTRAR**

CLAVE 1-0564
INNER 1 MASTER 6



**CENTRO DE CARGA
4 UNIDADES
SOBREPONER**

CLAVE 1-0565
INNER 1 MASTER 6



**SWITCH 1 POLO 1 TIRO
PORCELANA**

**CLAVE 22-SWPOR1500
INNER PZA / MASTER 10**



**SWITCH 2 POLOS 1 TIRO
PORCELANA**

**CLAVE 22-SWPOR2T
INNER PZA / MASTER 10**



FLOTADOR ELÉCTRICO

**CLAVE 21-GFE-MV-3M
INNER 6 / MASTER 24**

- CABLE DE 3 MTS
- PARA BOMBAS CON POTENCIA DE 1/2 Hp EN 120 O 220 VOLTIOS

- MULTIVOLTAJE IP-68 16AMP
- PARA USO EN TINACOS, CISTERNAS Y DEPÓSITOS DE AGUA.
- MATERIAL PLÁSTICO
- COMPONENTES ELÉCTRICOS INOXIDABLES.
- NO CONTIENE MERCURIO
- EXCELENTE CALIDAD



**BATERÍA
TECNOLOGÍA BATERÍA LITIO
VOLTAJE 3V BLISTER C/5 PZAS**

**CLAVE 3-CR-2025 / CLAVE 3-CR-2032
INNER 1 BLISTER MASTER 20**



FLOTADOR ELECTRICO

AKSI 5-191391

127 V / 60HZ 10 APM

**CABLE 3 MTS INNER 4 / MASTER 24
SIN MERCURIO**



**BATERÍA MP-23A
BATERÍA ALCALINA DE ALTO VOLTAJE 23A
BATERÍA TIPO GP**

**CLAVE 3-23A
INNER PZA / MASTER 28**

INTERRUPTORES



CLAVE	DESCRIPCION
PEG216B	BOTONERA 20 AMP C/120 PZAS
PEG-230	BOTONERA 30 AMP. C/100 PZAS
39-IB-QIUSA	QUINTA TERMINAL
53-ACO-012	FOTOCELDA COMPACTA 600W 90-260 V





OBRA NEGRA

CAJAS DE REGISTRO



CHALUPA GALVANIZADA

MEDIDA	CLAVE
1/2	29-1001
INNER PZA / MASTER 200	



CHALUPA GALVANIZADA

MEDIDA	CLAVE
1/2 Y 3/4	29-1001E
INNER PZA / MASTER 250	



CAJA CUADRADA GALVANIZADA

MEDIDA	CLAVE
1/2	29-1002E
INNER PZA MASTER 200	



CAJA CUADRADA GALVANIZADA

MEDIDA	CLAVE
3/4	29-1004E
INNER PZA / MASTER 100	

TAPA Y CANALETA



CHALUPA PLÁSTICA

CLAVE 29-1000
INNER PZA / MASTER 300



SOBRETAPA

MEDIDA **CLAVE**
3/4 29-4001E
INNER 10 / MASTER 200



TAPA CUADRADA GALVANIZADA

MEDIDA	CLAVE
1/2	29-3001E INNER 10 MASTER 1000
3/4	29-3003E INNER 10 MASTER 500

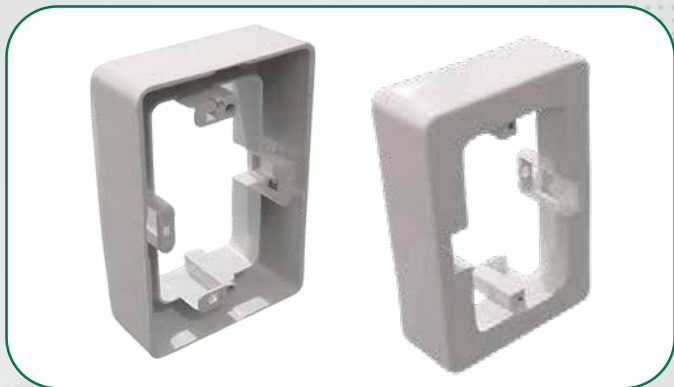

CAJA UNIVERSAL

CLAVE 25-CP2
INNER PZA / MASTER 220



**CANALETA PLÁSTICA 10X20
CON PEGAMENTO**

CLAVE 22-G2113
INNER PZA / MASTER 50



CANALETA PLÁSTICA 10X20

CLAVE 22-G2114
INNER PZA / MASTER 50

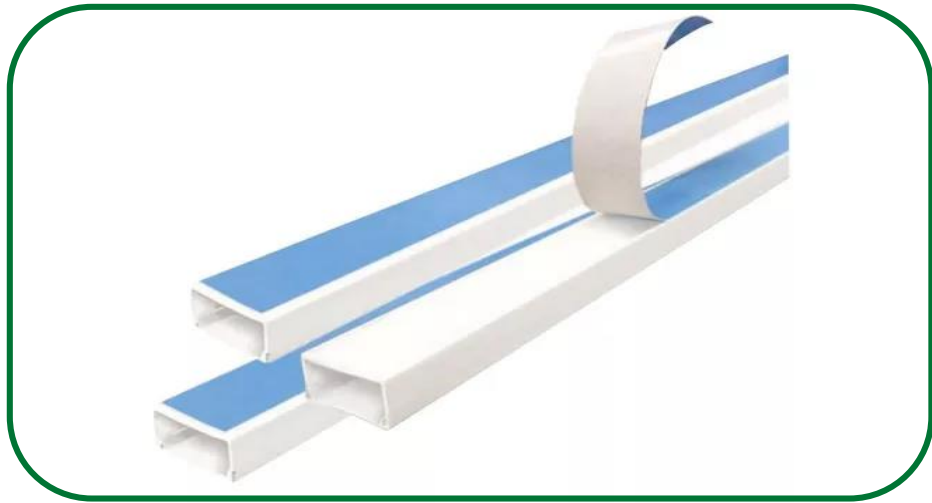

CLAVE	DESCRIPCION
22-G2115	CANALETA 15 X 7 CON PEGAMENTO
22-G2116	CANALETA 11 X 12 CON PEGAMENTO
22-G2017	CANALETA 20 X 17 CON PEGAMENTO
25-CP2CT	CAJA UNIVERSAL CON FONDO



CONECTOR, VARILLA Y GUÍA



CONECTOR PARA VARILLA DE ALUMINIO
TORNILLO AJUSTABLE
ENSAMBLE PARA VARILLA A TIERRA

CLAVE 1-0676
INNER 10 / MASTER 100



VARILLA PARA TIERRA FÍSICA

MEDIDA	CLAVE	INNER	MASTER
1 MTS	25-TUVD3	PZA	15
1.5 MTS	25-TUVD	PZA	10
75 CM 1/2"	25-TUVD2	PZA	10



GUÍA NYLON

METROS	CLAVE	INNER	MASTER
5 MTS	32-3X05	PZA	50
10 MTS	32-3X10	PZA	50
15 MTS	32-3X15	PZA	50
20 MTS	32-3X20	PZA	50



GUÍA ACERADA

METROS	CLAVE	INNER	MASTER
5 MTS	22-G050	PZA	50
10 MTS	22-G051	PZA	50
15 MTS	22-G052	PZA	50
20 MTS	22-G053	PZA	50
30 MTS	22-G055	PZA	50



ABRAZADERAS Y GRAPAS

ABRAZADERAS Y GRAPAS



GRAPA AISLADA

#	CLAVE	INNER	MASTER
2	12-GA2	5	100
3	12-GA3	5	100



GRAPA PARA INSTALAR CABLE REDONDO
INCLUYE CLAVO GALVANIZADO. **BOLSA CON 100 PZS**

MEDIDA	CLAVE	INNER	MASTER
5 MM	50-92-1005	PZA	300
6 MM	50-92-1006	PZA	300
8 MM	50-92-1007	PZA	300
10 MM	50-92-1008	PZA	250



GRAPA PARA INSTALAR CABLE PLANO
INCLUYE CLAVO GALVANIZADO. **BOLSA CON 100 PZS**

MEDIDA	CLAVE	INNER	MASTER
5 MM	50-92-1001	PZA	500
6 MM	50-92-1002	PZA	300
8 MM	50-92-1003	PZA	300
10 MM	50-92-1004	PZA	250



ABRAZADERA GALVANIZADA SIN FIN
BANDA Y CARCASA DE ACERO INOXIDABLE

MEDIDA	CLAVE	INNER	MASTER
DE 1/2" A 5/8" MINI # 4	1-0275	PZA	100
DE 1/2" A 3/4" MINI # 6	1-HGS23	PZA	100
DE 3/4" A 7/8" # 8	1-HGB23	PZA	100
DE 7/8" A 1" #10	1-0276	PZA	100

ABRAZADERAS Y GRAPAS

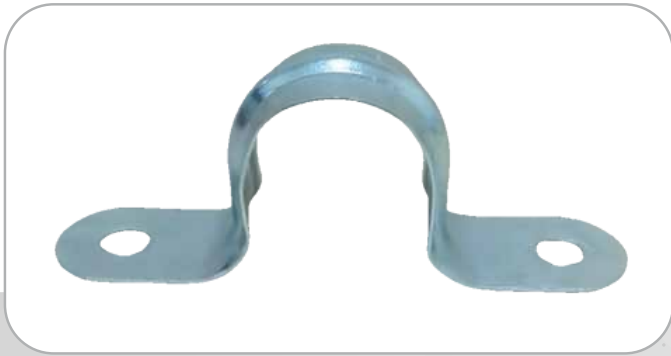

ABRAZADERA OMEGA
ABRAZADERA DE ACERO PARA TUBO CONDUIT

MEDIDA	CLAVE	INNER	MASTER
1/2" 13 mm	50-92-1009	PZA	100
3/4" 19 mm	50-92-1010	PZA	100
1" 25 mm	50-92-1011	PZA	100



ABRAZADERA UÑA
ABRAZADERA DE ACERO PARA TUBO CONDUIT

MEDIDA	CLAVE	INNER	MASTER
1/2" 13 mm	50-92-1014	PZA	100
3/4" 19 mm	50-92-1015	PZA	100
1" 25 mm	50-92-1016	PZA	100



ABRAZADERA PARA TUBO DE LED
CLIP PLÁSTICO DE POLICARBONATO

CLAVE 25-BVT8
INNER 10 / MASTER 100



TERMINAL PARA BATERÍA
MATERIAL COBRE

CLAVE 1-0675
INNER PZA / MASTER 100



CINCHO BLANCO
PRECIO POR BOLSA

CLAVE	MEDIDA	TENSIÓN	INNER	MASTER
			PZAS X BOLSA	BOLSA
5-103001	10 CM X 2,5 MM	18 LBS	100	200
5-103002	15 CM X 3,6 MM	40 LBS	100	100
5-103004	20 CM X 4,6 MM	50 LBS	50	50
5-103006	30 CM X 4,6 MM	50 LBS	50	100
5-103007	37 CM X 4,6 MM	50 LBS	25	100
5-103008	45 CM X 4,8 MM	50 LBS	25	100
5-103009	50 CM X 4,8 MM	50 LBS	25	100



CINCHO NEGRO
PRECIO POR BOLSA

CLAVE	MEDIDA	TENSIÓN	INNER	MASTER
			PZAS X BOLSA	BOLSA
5-103010	10 CM X 2,5 MM	18 LBS	100	200
5-103011	15 CM X 3,6 MM	40 LBS	100	100
5-103014	20 CM X 3,6 MM	40 LBS	50	100
5-103015	30 CM X 4,6 MM	50 LBS	50	100
5-103016	37 CM X 4,6 MM	50 LBS	25	100
5-103017	45 CM X 4,8 MM	50 LBS	25	100
5-103018	50 CM X 4,8 MM	50 LBS	25	100



CALENTADORES

CALENTADORES



CALENTADOR DE ALUMINIO

#	CAPACIDAD	CLAVE	INNER	MASTER
1	1LT	6-0001	PZA	100
2	2 LTS	6-0002	PZA	100
3	5 LTS	6-0003	PZA	100
4	8 LTS	6-0004	PZA	100
5	12 LTS	6-0005	PZA	100
6	20 LTS	6-0006	PZA	100



CALENTADOR DE ALUMINIO

#	CAPACIDAD	CLAVE	INNER	MASTER
7	25 LT	6-0010	PZA	100



CALENTADOR DE PLÁSTICO
PLÁSTICO RESISTENTE
ANTIFLAMA
NO FLOTA
CAPACIDAD 15 LTS

CLAVE 1-0220
INNER PZA / MASTER 50



CALENTADOR DE PORCELANA
CALENTADOR DE PORCELANA GRANDE
CAPACIDAD 25 LTS

CLAVE 6-0007
INNER PZA / MASTER 50



CALENTADOR REFORZADO (BOLSA)
CABLE POT
CALENTADOR DE ACERO #6 2000W KLEY
CAPACIDAD 20 LTS

CLAVE 1-0408
INNER PZA / MASTER 50



CALENTADOR REFORZADO LEÓN (CAJA)
ALUMINIO
POTENCIA DE 2000W / CAPACIDAD 20 LTS
CABLE USO RUDO DE 70 CM.

CLAVE 1-0409
INNER PZA / MASTER 100



REPUESTO PARA REGADERA ELÉCTRICA

CLAVE 1-0022
INNER PZA / MASTER 500



RESISTENCIA PARA CAFETERA
CAPACIDAD 1.5 LTS
MATERIAL ALUMINIO

CLAVE 6-0009
INNER PZA / MASTER 100



PARRILLAS

PARRILLAS Y ESTUFAS



ESTUFA DE GAS LP
CRISTAL TEMPLADO DE ALTA CALIDAD
2 QUEMADORES / TUBERÍAS DE COBRE
ENCENDIDO MECÁNICO / NEGRO BRILLANTE

CLAVE 1-0354
INNER PZA



ESTUFA DE GAS LP
LÁMINA REFORZADA
2 QUEMADORES / TUBERÍAS DE COBRE
ENCENDIDO MECÁNICO/ NEGRO BRILLANTE

CLAVE 1-0355
INNER PZA



ESTUFA DE GAS 2/4 QUEMADORES
USA GAS LP
DIFERENTES COLORES
LAMINA REFORZADA

CLAVE 1-0241 DOS QUEMADORES
CLAVE 1-0242 CUATRO QUEMADORES
INNER PZA



PARRILLA PORTATIL
ESTUCHE DE PLÁSTICO
ENCENDIDO ELECTRÓNICO
PARA GAS BUTANO / PROPANO

CLAVE 1-0353
INNER PZA / MASTER 6

PARRILLAS Y RESISTENCIAS



**PARRILLA ELÉCTRICA SENCILLA CON TERMOSTATO
RESISTENCIA DE 750 W
MATERIAL METÁLICO / CONTROL DE TEMPERATURA
INDICADOR DE ENCENDIDO**

**CLAVE 1-LS-PAE-01
INNER PZA / MASTER 12**



**PARRILLA ELÉCTRICA DOBLE CON TERMOSTATO
RESISTENCIAS DE 750 W / MATERIAL METÁLICO
CONTROL DE TEMPERATURAS
INDICADOR DE ENCENDIDO**

**CLAVE 1-0240
INNER PZA / MASTER 6**



**PARRILLA ELÉCTRICA MINI CON TERMOSTATO
PLATO DE HIERRO / POTENCIA MÁXIMA 500 W
MATERIAL LÁMINA REFORZADA CON TERMOSTATO
PARA REGULAR LA TEMPERATURA**

**CLAVE 1-0351
INNER PZA / MASTER 30**



**PARRILLA ELÉCTRICA SENCILLA CON TERMOSTATO
PLATO DE HIERRO / POTENCIA MAX 1000W
MATERIAL LÁMINA REFORZADA CON TERMOSTATO
PARA REGULAR LA TEMPERATURA**

**CLAVE 1-0350
INNER PZA / MASTER 12**



**PARRILLA ELÉCTRICA DOBLE CON TERMOSTATO
PLATO DE HIERRO / 1000 W POR HORNEADA
MATERIAL LÁMINA REFORZADA CON TERMOSTATOS
INDIVIDUALES PARA REGULAR LA TEMPERATURA**

**CLAVE 1-0352
INNER PZA / MASTER 6**



**PARRILLA BASE MADERA
MATERIAL METAL Y BASE DE MADERA
PARRILLA ELÉCTRICA**

**CLAVE 1-0239
INNER PZA**

PARRILLAS Y RESISTENCIAS



**PARRILLA ELÉCTRICA METÁLICA
CON RESISTENCIA**

**CLAVE 6-0093
INNER PZA**



**PARRILLA DE BARRO
ELÉCTRICA**

**CLAVE 6-0094
INNER PZA / MASTER 10**



**TERMOSTATO
PARA PARRILLA ELÉCTRICA**

**CLAVE 1- AS-02
INNER PZA**



**RESISTENCIA PARA PARRILLA
MOGUM / 800 W
USO PARA PARRILLAS UNIVERSALES**

**CLAVE 1-0243
INNER PZA / MASTER 120**

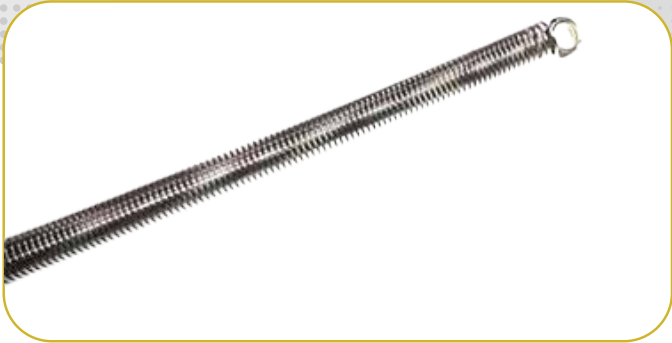

**RESISTENCIA OMME
PUEDE UTILIZARSE EN CALENTADORES CERÁMICOS
SECADORAS DE CABELLO /PISTOLAS DE CALOR
INCUBADORAS, ETC.**

CALIBRE	CLAVE	INNER	MASTER
16	11-GR16PR	10	100
18	11-GR18PR	10	100
20	11-GR20PR	10	100



**RESISTENCIA ELÉCTRICA PARA PARRILLA
RONAHE**

CALIBRE	CLAVE	INNER	MASTER
18	6-0011	10	100
20	6-0008	10	100



PLOMERÍA

PLOMERÍA



REGADERA ELÉCTRICA
CARCAZA DE PROPILENO DE ALTA RESISTENCIA
CONTACTOS INTERNOS ELÉCTRICOS CON PUNTA
DE PLATA / 127V 60Hz / 4400W
4 TEMPERATURAS

CLAVE 1-0129
INNER PZA / MASTER 24



REGADERA CUADRADA 8" X 8"
MATERIAL METAL TERMINADO
CROMO INOXIDABLE
81 PUNTOS DE SALIDA DE AGUA

CLAVE 1-0620
INNER PZA / MASTER 60

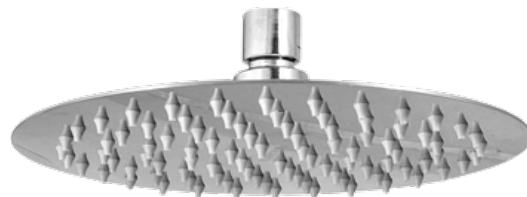

REGADERA REDONDA
8"
MATERIAL ACERO INOXIDABLE
CLAVE 1-0664

INNER PZA / MASTER 60

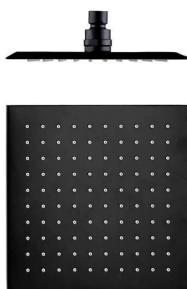

REGADERA NEGRA 8"
CLAVE 1-0227

PLOMERÍA



REGADERA CUADRADA 6"
MATERIAL METAL TERMINADO
CROMO INOXIDABLE
BOQUILLAS DE SILICONA ANTI SARRO
SENSACIÓN DE LLUVIA RELAJANTE

CLAVE 1-0665
INNER PZA / MASTER 100



REGADERA ANTI-SARRO
MATERIAL PVC CROMADO

CLAVE 1-0127
INNER PZA / MASTER 100



BRAZO PARA REGADERA CON CHAPETÓN 20 CM
MATERIAL ACERO INOXIDABLE

CLAVE 5-114806
BRAZO DE PLASTICO
CLAVE 5-308203

INNER PZA / MASTER 50



BRAZO PARA REGADERA CON CHAPETÓN
40/50 CM
MATERIAL ACERO INOXIDABLE

MEDIDA	CLAVE	INNER	MASTER
40 CM	1-0619	PZA	50
50 CM	1-0617	PZA	25



BRAZO NEGRO 40 CM
CLAVE 1.0346



BRAZO REFORZADO 40 CM
CLAVE 1-0622



CINTA TEFLÓN 1/2"
CLAVE 1-0247
INNER 10 / MASTER 1000

CINTA TEFLÓN 3/4"
CLAVE 1-0248
INNER 10 MASTER 500



CARTUCHO ÁRBOL
VUELTA COMPLETA / AGUA FRÍA
CUERPO DE LATÓN / DE COMPRESIÓN
CARTUCHO COMPATIBLE

CLAVE 7-11280 V3026
CLAVE 37-8991

INNER PZA / MASTER 100



CARTUCHO ÁRBOL P/MEZCLADORA
MEDIA VUELTA
COLOR ROJO

CLAVE 1-0101
INNER PZA / MASTER 10



JUEGO DE LLAVES CON CHAPETÓN
CROMADO

CLAVE 1-0659
INNER PZA / MASTER 100



AIREADOR
PRECIO POR BOLSA C/10 PZAS
CUERPO METÁLICO / ROSCA EXTERIOR
FILTRO DE ACERO INOXIDABLE / AREMRE

CLAVE 7-10191
INNER PZA / MASTER 100



AIREADOR
PRECIO POR BOLSA C/10 PZAS
CUERPO METÁLICO / ROSCA EXTERIOR
FILTRO DE ACERO INOXIDABLE / AREMRI

CLAVE 7-10192
INNER PZA / MASTER 100



TUERCA PARA GARZA DE 12"
CUERPO METÁLICO
PARA GARZA TIPO GANZO

CLAVE 7-10200 TMG12
INNER PZA / MASTER 1000



CUBRETALADRO PARA FREGADERO
CROMADO
ACERO INOXIDABLE

CLAVE 7-10163 CUBFC
CLAVE 37-8977
INNER PZA / MASTER 100



CUELLO FLEXIBLE PARA MEZCLADORA
GARZA FLEXIBLE / CUELLO METÁLICO
FLUJO FIJO Y ROCIADOR / CROMADA

CUELLO FLEXIBLE 48 CM (19")
CLAVE 1-0657
INNER PZA MASTER 50PZAS



GARAZA PARA MEZCLADORA
FREGADERO / CROMADA
CUERPO DE ACERO INOXIDABLE
TIPO COBRA

CLAVE 7-10195 GARCG
INNER PZA / MASTER 150



GARAZA PARA MEZCLADORA
FREGADERO
CUERPO DE ACERO INOXIDABLE
TIPO GANZO 12"

CLAVE 7-10193 GAR12
INNER 5 / MASTER 60



GARAZA PARA MEZCLADORA
FREGADERO / CROMADA
CUERPO DE ACERO INOXIDABLE
TIPO BASTÓN

CLAVE 7-10194 GARCA
INNER PZA / MASTER 6



CONTRACANASTA FREGADERO 3 1/2"
CON TUBO DE PVC
REGILLA Y ANILLO DE ACERO INOXIDABLE

CLAVE 5-130051
INNER 10 MASTER 40 PZAS



CONTRACANASTA PRA FREGADERO 3 1/2"
CROMADO / CONTRACANASTA 3 1/2"
CUBIERTA DE ACERO INOXIDABLE
CANASTILLA DE ACERO INOXIDABLE
EXTENSIÓN METÁLICA DE 10 CM

CLAVE 7-10174 CONCTM
INNER PZA / MASTER 50



MEZCLADORA LAVABO 4" CUELLO BAR
CLAVE 5-308303

REPUESTO 5-308391



MEZCLADORA LAVABO 4" CUELLO CORTO
CLAVE 5-308304

REPUESTO 5-308392



MONOMANDO LAVABO 4"
CLAVE 5-308305

REPUESTO 5-308396



LLAVE INDIVIDUAL PARA LAVABO
CLAVE 5-308306

REPUESTO 5-308394

MEZCLADORAS ¼ DE VUELTA "euro"



Mezcladora 8"
cuello de ganso
Clave 5-115101
Repuesto 5-115194



Mezcladora 8"
cuello de ganso
Clave 5-115104
Repuesto 5-115193



Mezcladora 8"
cuello de ganso
Clave 5-115103
Repuesto 5-115192



Mezcladora 8"
cuello de ganso
Clave 5-115102
Repuesto 5-115191



Mezcladora 8"
cuello de cobra
Clave 5-115105
Repuesto 5-115192



Mezcladora 8"
cuello de cobra
Clave 5-115106
Repuesto 5-115191

MEZCLADORAS ¼ DE VUELTA "euro"



Mezcladora 4"
cuello CURVO
Clave 5-115003
Repuesto 5-115192



Mezcladora 4"
cuello CURVO
Clave 5-115001
Repuesto 5-115194



Mezcladora 4"
cuello CURVO
Clave 5-115002
Repuesto 5-115191



Mezcladora 4"
cuello CURVO
Clave 5-115004
Repuesto 5-115195

MEZCLADORAS ¼ DE VUELTA "ABS"



Mezcladora 8''
cuello de ganso
Clave 5-308401
Repuesto 5-308391



Mezcladora 8''
cuello de ganso
Clave 5-308402
Repuesto 5-308392



Mezcladora 8''
cuello de cobra
Clave 5-308403
Repuesto 5-308393



Monomando 8''
Clave 5-308404
Repuesto 5-308395



Mezcladora 4''
cuello CURVO
Clave 5-308301
Repuesto 5-308391



Mezcladora 4''
cuello CURVO
Clave 5-308302
Repuesto 5-308392

CURVA
1-0803



HEXAGONAL
1-0805



CRUZ
1-0806



CRUZETA
1-0804



PALANCA
1-0800



CRUZETA
1-0801



CURVA
1-0802







MEZCLADORA LAVABO / CROMADA
1/4 DE VUELTA / GARZA FLEXIBLE
CUERPO METÁLICO
CUBIERTA Y MANERALES DE ABS
FLUJO FIJO Y ROCIADOR / PRESIÓN BAJA
CARTUCHOS CERAMICOS BKA426

CLAVE 7-20049 BKA1891
INNER PZA / MASTER 20



MEZCLADORA PARA FREGADERO
CUBIERTA Y MANERALES ABS
CROMADA
VUELTA COMPLETA

CLAVE 7-20009 BKA796C
INNER PZA / MASTER 20



MEZCLADORA MONOMANDO PARA FREGADERO
CUELLO FLEXIBLE / CUERPO METÁLICO
MANERAL METÁLICO / CARTUCHO DE ABS
45 CM DE ALTO

CLAVE 7-20039 BKMM1029
INNER PZA / MASTER 12



MEZCLADORA PARA LAVABO DE CRUZETA
MANERAL DE CRUZETA
MANERALES DE PLÁSTICO
CONEXIONES DE BRONCE

CLAVE 1-0124
INNER PZA / MASTER 20



CUERPO DE ZINC / MANERALES DE ABS
CUELLO FLEXIBLE METÁLICO

CLAVE 1-0661
INNER PZA / MASTER 20



MEZCLADORA FREGADERO
MATERIAL BRONCE Y METAL
MANERAL DE CRUCETA
MEDIA VUELTA
TERMINADO DE CROMO PULIDO

CLAVE 1-0130
INNER PZA / MASTER 20



JUNTA SENCILLA
W.C.
CERA
SIN GUÍA

CLAVE 1-0223
INNER PZA / MASTER 104



JUNTA CON CONO
SELLADOR DE FUGAS / EVITA LOS MALOS OLORES
FIJACIÓN RÁPIDA Y DURADERA
CUERPO DE CERA

CLAVE 1-0222
INNER PZA / MASTER 96



MEZCLADORA PARA FREGADERO
ECONOMICA CUELLO LARGO, MANERAL
DE ACRILICO, BAJA PRESIÓN.

CLAVE 37-8951
INNER PZA MASTER 20 PZAS



JUEGO DE HERRAJES
HERRAJE SENCILLO / MANIJA BLANCA
VÁLVULA CÔD. 90
TORNILLOS DE PLÁSTICO

CLAVE 1-0339
INNER PZA / MASTER 20



VÁLVULA
TANQUE BAJO

CLAVE 1-0283
INNER PZA / MASTER 100



EMPAQUE ESPONJOSO PARA SANITARIO 2 NEGRO
CLAVE 7-10657

CLAVE 37-9307
INNER PZA / MASTER 300

PLOMERÍA



SAPO PARA W.C.
3\"/>

2\"/>



MANIVELA DE DESCARGA METÁLICA

CLAVE 7-10667 MANSM
INNER PZA / MASTER 200



TORNILLO PARA CAJA DE W.C.
TORNILLOS DE ACERO TROPICALIZADO

CLAVE 1-0670
INNER PZA / MASTER 100



TORNILLO DE SUJECCIÓN TAZA
TANQUE METÁLICO
PRECIO POR JUEGO

CLAVE 7-10698
CLAVE 37-5987
INNER 30 / MASTER 200



PIJA TROPICALIZADA
SE USA PARA SUJETAR LA TAZA
DEL BAÑO AL PISO

CLAVE 1-0621
INNER PZA / MASTER 100



VÁLVULA PERA PERFECTA
PARA W.C.

CLAVE 1-0080B
INNER PZA / MASTER 100

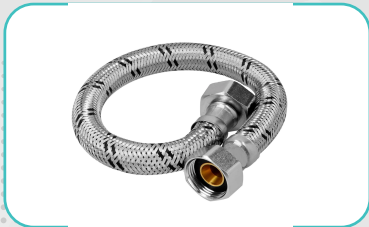

MANGUERA FLEXIBLE PARA BOILER
60 CM 1/2\"/>

60 CM 3/4\"/>

INNER PZA MASTER 10 PZAS

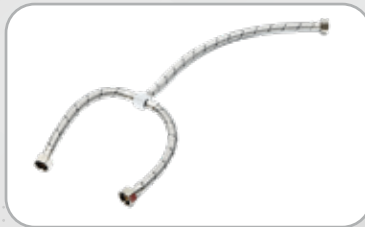

MANGUERA FLEXIBLE TIPO \"T\"
PARA LAVABO Y FREGADERO
TRENZADO DE ALUMINIO / TUERCA DE ZINC CROMADA
EMPAQUE DE NEOPRENO / PIVOTE EN ABS REFORZADO

CLAVE 50-18-9568
INNER 10 / MASTER 100



MANGUERA FLEXIBLE
PARA MONOMANDO / 50 CM
TRENZADO DE ALUMINIO
TUERCA DE ZINC CROMADA
CONECTOR M10X1/2\"/>

CLAVE 5-103313
INNER 10 / MASTER 100



MANGUERA PARA FREGADERO
55 CM
TRENZADO EN ALUMINIO

CLAVE 1-0147
CLAVE 5-307601
INNER 10 / MASTER 100



MANGUERA PARA LAVABO
50 CM
TRENZADO EN ALUMINIO

CLAVE 1-0146
CLAVE 5-30764 40CM
INNER 10 / MASTER 100



MANGUERA PARA W.C.
45 CM
TRENZADO EN ALUMINIO
MANGUERA INTERNA DE EPDM

CLAVE 1-0152
CLAVE 5-307602 35CM
INNER 10 / MASTER 100



CESPOL FLEXIBLE PARA FREGADERO

CLAVE 1-0641
INNER PZA / MASTER 10



CESPOL FLEXIBLE PARA LAVABO

CLAVE 1-0642
INNER 10 / MASTER 10



CESPOL FLEXIBLE MULTIUSOS

CLAVE 37-8570
INNER PZA / MASTER 24



COLADERA INTEGRAL MATERIAL PVC

C/REJILLA ALUMINIO **CLAVE 1-0649**
C/REJILLA PVC BLANCA **CLAVE 1-0650**
C/REJILLA PVC CROMADA **CLAVE 1-0651**
INNER PZA / MASTER 100



COLADERA UNIVERSAL

C/REJILLA ALUMINIO **CLAVE 1-0652**
C/REJILLA PVC BLANCA **CLAVE 1-0653**
C/REJILLA PVC CROMADA **CLAVE 1-0672**
INNER PZA / MASTER 100



COLADERA CESPOL 1 SALIDA

C/REJILLA ALUMINIO **CLAVE 1-0643**
C/REJILLA PVC BLANCA **CLAVE 1-0645**
C/REJILLA PVC CROMADA **CLAVE 1-0648**
INNER PZA / MASTER 50



COLADERA CESPOL 2 SALIDAS

C/REJILLA ALUMINIO **CLAVE 1-0644**
C/REJILLA PVC BLANCA **CLAVE 1-0646**
C/REJILLA PVC CROMADA **CLAVE 1-0647**
INNER PZA / MASTER 50



REJILLA PARA COLADERA

ALUMINIO **CLAVE 1-0666**
BLANCA PVC **CLAVE 1-0667**
CROMADA PVC **CLAVE 1-0668**
INNER PZA / MASTER 25



CONECTOR P/LAVADORA 3/4" X 3/4" X 120 CM
TEMPERATURA 0°C - 80°C
PRESION 7KG/CM2

CLAVE 7-11411
INNER PZA / MASTER 40



MANGERA DE DESAGÜE 1.8M

CLAVE 7-11420
INNER PZA / MASTER 20



MULTICONECTOR PARA TINACO
FÁCIL INSTALACIÓN
NO PRODUCE ÓXIDO NI SARRO
MATERIAL DE ALTA RESISTENCIA

CLAVE 1-0150
INNER PZA / MASTER 50



LLAVE PORTA GARRAFÓN
BLANCO
PLÁSTICO

CLAVE 1-0302
INNER PZA / MASTER 104



HERRAMIENTAS

HERRAMIENTAS



KIT DE TERMOFUSIÓN
ESTUCHE METÁLICO
TERMOFUSOR / BASE DE TERMOFUSOR
LLAVE ALLEN
JUEGO DE DADOS (63mm, 50mm, 40mm, 32mm, 25mm, 20mm)
CLAVE 7-11069 KPPR89
INNER PZA / MASTER 4



CAUTÍN DE LÁPIZ CON SOLDADURA Y PASTA
120V-60Hz
60W
INCLUYE SOLDADURA Y PASTA PARA SOLDAR

CLAVE 1-0425
INNER PZA / MASTER 100



MULTÍMETRO DIGITAL PROFESIONAL
OPERA CON BATERÍA 9V
PANTALLA LCD
PROBADOR DE TENSIONES
INDICADOR DE TOTALIDAD

CLAVE 50-92-1366
INNER PZA / MASTER 60

HERRAMIENTAS



JUEGO DESARMADOR JOYERO
4 PUNTAS PLANAS
2 PUNTAS PHILLIPS
ESTUCHE DE PLÁSTICO

CLAVE 1-0268

AKSI 5-307502
INNER 6 / MASTER 96



ARCO CON SEGUETA
CUERPO DE ACERO
MATERIAL DE ABS
SEGUERA DE 12"

CLAVE 1-0562

INNER PZA / MASTER 15



CANDADOS 25 MM KIT C/2PZS
CANDADO MALETERO EN BLISTER
METAL / DORADO

CLAVE 1-0225

INNER PZA / MASTER 30



CANDADO DE ACERO
ALTA SEGURIDAD NIVEL 7

MEDIDA	CLAVE	INNER	MASTER
30 MM	1-LE-S30	PZA	12
40 MM	1-LE-S40	PZA	12
50 MM	1-LE-S50	PZA	12



JUEGO DE 5 PUNTAS 2"
FABRICADAS DE ACERO AL CROMO VANADIO
BLISTER
10 AÑOS DE GARANTÍA

CLAVE 5-114002

INNER 12 / MASTER 72



CANDADO LLAVE TETRA
CUERPO DE ACERO CROMADO / CILINDRO DE ACERO
ALTA SEGURIDAD NIVEL 7

MEDIDA	CLAVE	INNER	MASTER
32 MM	1-LE-G32-P	PZA	10
38 MM	1-0231	PZA	10
50 MM	1-0232	PZA	10

HERRAMIENTAS



**NAVAJA DE UN FILO
PARA CORTES EN GENERAL Y RASPADO
CAJA CON 100PZ**

**CLAVE 7-68964 TPBLADE100
INNER PZA / MASTER 50**



**DISCO DE CORTE METAL
ÓXIDO DE ALUMINIO DE ALTA CALIDAD.
4 1/2" X .047" X 7/8"**

**CLAVE 1-0656
INNER 10 / MASTER 30**



**DISCO DE SIERRA PARA MADERA
40 DIENTES / CENTRO DE 5/8"
DIENTES DE CARBURO DE TUNGSTENO
DIÁMETRO 4 3/8"**

**CLAVE 7-67350 TPSBC41240
INNER PZA / MASTER 20**



**PALA IRROMPIBLE
MANGO POLICARBONATO AUTOMOTRIZ FLEXIBLE
LÁMINA, ACERO AL CARBÓN CAL.16
UN AÑO DE GARANTÍA**

**CLAVE 37-7417 ROJA 37-7400
INNER PZA / MASTER 6**



BROCHA CON MANGO DE PLÁSTICO

MEDIDA	CLAVE	INNER	MASTER
1/2"	5-301501	24	600
1"	5-301502	24	600
1 1/2"	5-301503	24	480
2"	5-301504	24	480
2 1/2"	5-301505	12	240
3"	5-301506	12	180
4"	5-301507	12	120
5"	5-301508	6	120
6"	5-301509	6	120



**FLEXÓMETRO
PUNTA IMANTADA / ANTI IMPACTO
ANCHO 23"**

MEDIDA	CLAVE	INNER	MASTER
3 MTS	1-0366	PZA	12
5 MTS	1-0367	PZA	12

HERRAMIENTAS



REMACHADORA 10"
REMACHES INCLUIDOS
CILINDRO FABRICADO EN ACERO TEMPLADO
MANGOS CUBIERTOS EN VINILO

CLAVE 1-0669
INNER PZA / MASTER 10



PISTOLA CALAFATEADORA
PARA SILICÓN DE CARTUCHO
METÁLICA

CLAVE 1-0563
INNER PZA / MASTER 10



PROBADOR DE CORRIENTE DESARMADOR.
VERDE
14.5 CM DE LARGO
CAPACIDAD DE 100/500V

CLAVE 1-0047 SANELEC 37-1575
INNER PZA / MASTER 12



PROBADOR DE CORRIENTE DIGITAL
MEDICIÓN INDIVIDUAL PARA AC/DC
12-200V~
PUNTA DESARMADOR

CLAVE 7-85833 STPC1138
INNER PZA / MASTER 30



PROBADOR DE CORRIENTE CON CABLES
127V-60 Hz
CUERPO DE BAQUELITA
HERRAJES Y PATA DE LATÓN

CLAVE 4-03206
INNER PZA / MASTER 25



TUBO DE SOLDADURA
2.70 MTS
TUBO SOLDADURA PARA CAUTÍN
DE 1 mm CON ALMA DE RESINA
ALEACIÓN 60%/40% PLOMO

CLAVE 3-023
INNER 10 / MASTER 100

HERRAMIENTAS



**PASTA PASA SOLDAR
LATA AZUL
25grs**

**CLAVE 16-SOL-025
INNER PZA / MASTER 250**



**ANTENA DE CONEJO SENCILLO
CON CABLE COAXIAL**

**CLAVE 3-012
INNER PZA / MASTER 50**



**ANTENA DE CONEJO CON BASE COAXIAL
RANGO DE FRECUENCIA 5-860MHz
4 SECCIONES DE BARRA / 800mm DE LARGO DE CABLE**

**CLAVE 3-013
INNER PZA / MASTER 30**



**CAIMÁN GRANDE
REVESTIMIENTO DE PLÁSTICO
PRECIO POR BOLSA / ROJO Y NEGRO
ANTI CORTOS CIRCUITOS**

**CLAVE 1-0342
INNER BOLSA / MASTER 10**



**CAIMÁN MEDIANO
REVESTIMIENTO DE PLÁSTICO
ROJO Y NEGRO / PRECIO POR BOLSA
ANTI CORTOS CIRCUITOS**

**CLAVE 1-0343
INNER BOLSA / MASTER 10**



**CAIMÁN CHICO CON CABLE 3A
FABRICADOS EN LÁMINA / ACABADO NIQUELADO
PRECIO POR ATADO 10 JUEGOS
SOPORTAN HASTA 3 AMPERES**

**CLAVE 16-CAI-201
INNER ATADO / MASTER 10**

HERRAMIENTAS



MANGUERA DE ½ PARA JARDIN
CON CONECTOR

- 5-102903 10MTS
- 5-102904 15MTS
- 5-102905 20MTS



MANGUERA DE ½ PARA JARDIN
5-102909 100MTS



SEGUETAS BIMETALICAS

- 5-107501 18DPP
- 5-107502 24DDP
- INNER 10P / MASTER 50P



MANGUERA INDUSTRIAL 3/8
5-102922 100MTS



MINI ARCO 12" C/SEGUETA
5-301003 INNER 6 / MASTER 72



LÍQUIDOS Y SILICONES

LÍQUIDOS Y SILICONES



AIRE COMPRIMIDO
340 GR
PRODUCTO ESPECIAL PARA COMPUTADORAS
Y EQUIPOS ELECTRÓNICOS.

CLAVE 16-TORNADO
INNER PZA / MASTER 24



AFLOJATODO
170 GR / PROTEGE / DISUELVE
AFLOJA / ANTIOXIDANTE / PENETRA
LIMPIA / ANTICORROSIVO

CLAVE 1-0177
INNER PZA / MASTER 24



GAS PARA ENCENDEDOR
180 ML
PRODUCTO INFLAMABLE

CLAVE 1-0235
INNER PZA / MASTER 24



GAS PARA ESTUFILLA
220 ML / IDEAL PARA SOPLETES, ESTUFAS,
LÁMPARAS PORTÁTILES Y MÁS
PRODUCTO INFLAMABLE

SANTUL 37-7581 CLAVE 1-0288
INNER 6 / MASTER 24

LÍQUIDOS Y SILICONES



GAS PARA SOPLETE
275 ML / IDEAL PARA SOPLETES, ESTUFAS,
LÁMPARAS PORTÁTILES Y MÁS.
PRODUCTO INFLAMABLE

CLAVE 1-0289

SANTUL 37-7580
INNER 6 / MASTER 24



SELLADOR DE SILICÓN
70 G / NEGRO / USO AUTOMOTRIZ
RESISTENCIA A FLUIDOS DE TRANSMISIÓN,
AGUA, ACEITE Y ANTICONGELANTES
RESISTE TEMPERATURAS DE 0°C HASTA 310°C

AKSI 5-105221
INNER PZA / MASTER 12



SELLADOR DE SILICÓN
70 G / ROJO / USO AUTOMOTRIZ
RESISTENCIA A FLUIDOS DE TRANSMISIÓN, AGUA,
ACEITE Y ANTICONGELANTES.
RESISTE TEMPERATURAS DE 0°C HASTA 310°C

AKSI 5-105222
INNER PZA / MASTER 12



SILICÓN TRANSPARENTE EN BLISTER
85 GR / USO GENERAL
PARA INTERIORES Y EXTERIORES.
EXCELENTE ADHERENCIA EN VIDRIO,
ALUMINIO, AZULEJO, MADERA, ETC

SANTUL 37-5723 **CLAVE 1-0270**
AKSI 5-105211 INNER PZA / MASTER 12



SILICÓN TRANSPARENTE EN CARTUCHO
280 ML / USO GENERAL PARA INTERIORES Y EXTERIORES.
EXCELENTE ADHERENCIA EN VIDRIO, ALUMINIO, AZULEJO,
MADERA, ETC. / SELLADOR NO PINTABLE.
EN CLIMAS MUY SECOS, COLOQUE TRAJOS HUMEDECIDOS
CERCA DEL SILICÓN PARA AYUDAR A SU VULCANIZACIÓN.

CLAVE 1-0271 **SANTUL 37-5724**
INNER PZA / MASTER 24 **AKSI 5-105201**



SILICÓN BLANCO EN CARTUCHO
280 ML / USO GENERAL PARA INTERIORES Y EXTERIORES.
EXCELENTE ADHERENCIA EN VIDRIO, ALUMINIO, AZULEJO,
MADERA, ETC / SELLADOR NO PINTABLE.
EN CLIMAS MUY SECOS, COLOQUE TRAJOS HUMEDECIDOS
CERCA DEL SILICÓN PAR AYUDAR A SU VULCANIZACIÓN.

SANTUL 37-5730 **CLAVE 1-0178**
AKSI 5-105202 INNER PZA / MASTER 24



SILICON BLANCO 85GR.
USO GENERAL
CLAVE **37-5729**
INNER 12 / MASTER 144



ADHESIVO SIN CLAVOS
300 ML
CLAVE **37-5727**
INNER 1 MASTER 24

ESPUMA EXPANSIVA
MULTIUSOS
DE 500ML
CLAVE **37-5725**
DE 750ML
CLAVE **37-5726**
INNER 1 / MASTER 15





*Av. PACÍFICO 497 local 1, PUEBLO de la CANDELARIA, CDMX
Coyoacán, C.P. 04380 55 5421 3803 / 55 6831 2868*

otercom@yahoo.com.mx

www.otercom.com